



MILLENNIAL
TOUCH SCREEN

MILLENNIAL
SMART

MILLENNIAL
BLACK MASK

MILLENNIAL
DECK









MILLENNIAL









Bakery & Pastry



Indice

Index

About Tecnoeka			Pag. 4
About Millennial			Pag. 6
Ogni codice ti racconta una storia Each code tells you a story			Pag. 8
Design			Pag. 10
Airflowlogic™			Pag. 12
Humilogic™			Pag. 14
Drylogic™			Pag. 16
Sistema di lavaggio Washing system			Pag. 18
Plus M I L L E N N I A L TOUCH SCREEN			Pag. 19
M I L L E N N I A L TOUCH SCREEN			Pag. 20
M I L L E N N I A L BLACK MASK			Pag. 22
M I L L E N N I A L SMART			Pag. 24
Bakery & Pastry	Forni elettrici e gas Electric and gas ovens		Pag. 26
MKF 464	Forno combinato convezione vapore 4 teglie 600 x 400 mm Combi oven 4 trays 600 x 400 mm		Pag. 28
MKF 664	Forno combinato convezione vapore 6 teglie 600 x 400 mm Combi oven 6 trays 600 x 400 mm		Pag. 30
MKF 1064	Forno combinato convezione vapore 10 teglie 600 x 400 mm Combi oven 10 trays 600 x 400 mm		Pag. 32
MKF 1664	Forno combinato convezione vapore 16 teglie 600 x 400 mm Combi oven 16 trays 600 x 400 mm		Pag. 34
MKFD 1T	Forno DECK elettrico con vapore 1 teglia 600 x 400 mm Electric DECK oven 1 tray 600 x 400 mm with steam		Pag. 36
MKFD 2T	Forno DECK elettrico con vapore 2 teglie 600 x 400 mm Electric DECK oven 2 trays 600 x 400 mm with steam		Pag. 36

Lievitatori e mantenitori Proofers and holding cabinets	Lievitatori e mantenitori elettrici per forni Electric proofers and holding cabinets for ovens	⚡		Pag. 38
MKL 1064 S	Lievitatore elettrico per forni 4, 6 e 10 teglie S e forno DECK 1 teglia Electric proofer for 4, 6 and 10 trays ovens S and 1 tray DECK oven	⚡		Pag. 39
MKLM 1064	Lievitatore e mantenitore elettrico per forni 4, 6 e 10 teglie BM e TS, comandato dal forno Electric proofer and holding cabinet for 4, 6 and 10 trays BM and TS ovens, controlled by the oven	⚡		Pag. 40
Cappe Condensation hoods	Cappe elettriche di aspirazione a condensazione per forni Electric condensation hood for ovens	⚡		Pag. 42
MKKC 4 S	Cappa elettrica di aspirazione a condensazione per forni 4 teglie S Electric condensation hood for 4 trays ovens S	⚡		Pag. 43
MKKC 4	Cappa elettrica di aspirazione a condensazione per forni 4 teglie BM e TS, comandata dal forno Electric condensation hood for 4 trays BM and TS ovens, controlled by the oven	⚡		Pag. 43
MKKC 610 S	Cappa elettrica di aspirazione a condensazione per forni 6 e 10 teglie S Electric condensation hood for 6 and 10 trays ovens S	⚡		Pag. 44
MKKC 610	Cappa elettrica di aspirazione a condensazione per forni 6 e 10 teglie BM e TS, comandata dal forno Electric condensation hood for 6 and 10 trays BM and TS ovens, controlled by the oven	⚡		Pag. 44
MKKC 1620 S	Cappa elettrica di aspirazione a condensazione per forni 16 e 20 teglie S Electric condensation hood for 16 and 20 trays ovens S	⚡		Pag. 45
MKKC 1620	Cappa elettrica di aspirazione a condensazione per forni 16 e 20 teglie BM e TS, comandata dal forno Electric condensation hood for 16 and 20 trays BM and TS ovens, controlled by the oven	⚡		Pag. 45
Tavoli e carrelli Tables and trolleys				Pag. 46
Complementi Optional				Pag. 48
Teglie e griglie Trays and grids				Pag. 52
Versatilità 600 x 400 mm 600 x 400 mm Modular design				Pag. 54
Versatilità DECK DECK Modular design				Pag. 57
Comparativo compatibilità Comparative of compatibility				Pag. 59

About Tecnoeka



Il futuro è iniziato nel 1978

Siamo nati nel 1978 per portare avanti idee forti e innovative, sulle quali abbiamo costruito giorno dopo giorno la nostra unicità. L'acciaio è la nostra materia prima.
L'elemento col quale creiamo macchine con un cuore e un'anima.
Perché dietro ogni singolo forno, c'è sempre un gruppo di persone.
Uomini e donne che uniscono la loro capacità e passione per sviluppare la soluzione più avanzata e raggiungere gli obiettivi più ambiziosi.
L'innovazione tecnologica è la nostra firma.
Immettiamo sul mercato solo le tecnologie più performanti grazie alle conoscenze ingegneristiche più avanzate.
Continuiamo a superarci costantemente creando forni professionali attraverso processi evoluti, responsabili ed efficienti.
Il design italiano è il nostro orgoglio.
Crediamo nella creatività, qualità ed affidabilità italiana.
Coniughiamo la ricerca estetica con la funzionalità, nei nostri prodotti così come nel nostro headquarter, costruito e organizzato attraverso concetti di architettura, tecnologia e rispetto per l'ambiente.
La soddisfazione dei professionisti della ristorazione è il nostro obiettivo, perseguito sempre con maggiore impegno e con grande soddisfazione.
Un'attitudine che ci permette di dar lustro all'abilità ingegneristica italiana in più di 100 paesi nel mondo, varcando ogni giorno nuovi confini grazie al nostro nome, alla nostra storia e alla nostra idea di ristorazione.

The future began in 1978

We were born in 1978 to pursue strong and innovative ideas, on which we have built our day-to-day uniqueness. Steel is our raw material.
The element with which we create machines with a heart and soul.
Because behind every single oven there is always a group of people.
Men and women who combine their ability and passion to always develop the most advanced solution and achieve the most ambitious goals.
Technological innovation is our signature.
We only introduce the most efficient technologies on the market, thanks to the most advanced specialist knowledge. We continue to surpass ourselves by creating professional ovens through evolved, responsible and efficient processes.
Italian design is our pride.
We believe in Italian creativity, quality and reliability.
We combine aesthetic research with functionality, in our products as well as in our headquarters, built and organised through concepts of architecture, technology and respect for the environment.
Our goal lies in the satisfaction of catering professionals. Always sought for with utmost commitment and great gratification.
An attitude that allows us to give distinction to Italian engineering skills in more than 100 countries around the world.
Every day new frontiers are crossed thanks to our name, our history and our idea of catering.

About Millennial



Ci sono sfide che ti spingono oltre i limiti di ciò che è conosciuto,
e superare il limite a volte può fare paura.
Non a noi.

Il coraggio e la passione sono la firma che mettiamo dentro ad ogni progetto.
Una firma scolpita a chiare lettere sull'acciaio della linea MILLENNIAL.
Siamo orgogliosi di presentarvi la nuova generazione di forni progettata per soddisfare e stupire il professionista della ristorazione durante il suo lavoro quotidiano.
Con MILLENNIAL la qualità costruttiva incontra il futuro della ristorazione per dare alla luce qualcosa che non si era mai visto prima.

MILLENNIAL
è **tecnologia**, è **design**, è **semplicità** di utilizzo.

MILLENNIAL è la differenza tra chi parla di qualità e chi conosce il significato profondo di questa parola.
La differenza tra chi percorre sempre le stesse strade e chi, come noi, porta l'innovazione nelle cucine di tutto il mondo attraverso il coraggio delle idee.

There are challenges that push you beyond the limits of what is known.
And overcoming the limit can sometimes be scary.
Not for us.

Courage and passion are our signature in each project.
A signature sculpted in clear letters on the steel of the MILLENNIAL line.
We are proud to introduce you to the new generation of ovens designed to satisfy and amaze catering professionals during their daily work.
With MILLENNIAL the constructive quality meets the future of catering to bring something to light that has never been seen before.

MILLENNIAL
is **technology**, it's **design** and it's **easy** to use.

MILLENNIAL is the difference between those who speak of quality and those who know the deep meaning of this word.
The difference between those who always walk the same streets and those who like us, bring innovation to kitchens around the world through courageous ideas.

Ogni codice
ti racconta
una storia
Each code
tells you
a story

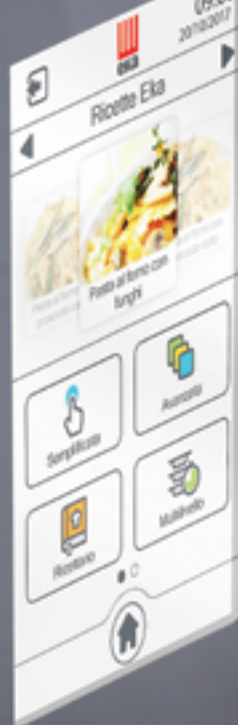

Ogni codice ti racconta una storia

Each code tells you a story

MKF 6 11 V CTS P

Famiglia

Family
E Evolution
M Millennial

Marchio

Brand
K Eka

Prodotto

Product
F forno/oven
FD forno deck/deck oven
C cucina/cooker
P piano di cottura da appoggio
counterop cooking plan
KC cappa a condensazione/condensation hood
LM lievitatore e mantentore/proofer and holding cabinet
L lievitatore/proofer
M mantentore/ holding cabinet
CR carrello/trolley
T tavolo/table
TS tavolo con supporti/table with supports
TR tavolo con ruote/table with wheels
TRS tavolo con ruote e supporti/table with wheels and supports
TSD tavolo con supporti deck/table with supports deck
TPL tavolo polli/closet
S kit sovrapposizione forni/kit for overlapping ovens
ST kit sovrapposizione tavoli/kit overlapping tables
SST kit sovrapposizione forni con supporti teglie
kit for overlapping ovens with trays supports
SCMU sonda al cuore multipunto/multi-point core probe
SCMO sonda al cuore monopunto/single-point core probe
SCSV sonda al cuore sottovuoto/vacuum cooking core probe
SSC/A supporto sonda al cuore/support for core probe
AF affumicatore/smoker
CG concentratore grasso/fat concentrator
FCA filtro carboni attivi/activated carbon filter
RCA ricarica carboni attivi/activated carbon
BZ buzzer
WT sistema di lavaggio automatico/automatic washing system
DET detergente e brillantante LT. 10/detergent and rinse aid LT. 10
DETS detergente e brillantante LT. 5/detergent and rinse aid LT. 5
KR kit ruote/set of whells
KD kit doccia/spray kit
KAF addolcitore LT. 8/water softener LT.8
TA testata di connessione cartuccia filtrante
per trattamento acqua potabile/filter head for water optimisation
CA cartuccia filtrante per trattamento acqua potabile
filter for water optimisation
KPI kit prima installazione TS/first installation kit TS
KPIC kit prima installazione TS (compact)
first installation kit (compact)
KPI-BMS kit prima installazione BM e S/first installation kit BM and S
KPIC-BM kit prima installazione BM (compact)
first installation kit BM (compact)
CKIT kit cappa Millennial BM e TS
Millennial condensation hood kit BM e TS
CSKIT kit cappa Millennial S/Millennial condensation hood kit S

Numero teglie

Number of trays

3 tre teglie/three trays
4 quattro teglie/four trays
5 cinque teglie/five trays
6 sei teglie/six trays
7 sette teglie/seven trays
10 dieci teglie/ten trays
11 undici teglie/eleven trays
12 dodici teglie/twelve trays
16 sedici teglie/sixteen trays
20 venti teglie/twenty trays
1T uno teglia deck/one tray deck
2T due teglie deck/two trays deck

Caratteristiche Linea

Line Features
P pratico/practical

Linea

Line
S smart
BM black mask
TS touch screen

Linea forno

Oven line
C compact
(larghezza 500 mm)
(width 500 mm)

Caratteristiche Features

D double
(per sovrapposizione forni)
(for overlapping ovens)
V boiler
G gas
2 con 2 motori
with 2 motors
U umidificazione a pulsante
humidification by a button
UD vapore diretto
direct steam
.3 aumento di potenza
power increasing
GRILL resistenza grill
grill heating element
M multifunzione
multifunction
AL apertura laterale
side opening
R ruote
wheels
IX acciaio
stainless steel

Tipologia di teglia

Tray dimension
11 1/1 GN
12 1/2 GN (325 x 265 mm)
21 2/1 GN
23 2/3 GN (354 x 325 mm)
23 429 x 345 mm
43 480 x 340 mm
64 600 x 400 mm

Dimensioni esterne

External dimensions
96 900 x 600 mm
(cucine/cookers)

Design



Vetro interno porta termoriflettente per ridurre i consumi energetici, apribile e facilmente pulibile

Heat-reflecting internal glass to reduce energy consumption, easy to clean thanks to the unlock system

Protezione contro l'acqua IPX 4, IPX5 (forni elettrici) e IPX3, IPX4 (forni a gas)

IPX4, IPX5 (electric ovens) and IPX3, IPX4 (gas ovens) waterproof

Maniglia con chiusura a croce
Handle with cross closing

Camera di cottura in acciaio AISI 304 10/10 con fondo camera stampato e bordi completamente arrotondati

Cooking Chamber in Stainless Steel AISI304 10/10mm, with moulded bottom and fully rounded edges

Piedini regolabili
Adjustable feet



Porta reversibile con cerniera a scomparsa

Reversible door with concealed hinge

Supporti laterali in lamiera progettati per una migliore uniformità di cottura e rimovibili per facilitare la pulizia

Sheet metal made trays supports designed for a better uniformity of cooking and removable for a better cleaning

Touch screen di serie su forni MILLENNIAL TS
standard on MILLENNIAL TS

Push-button di serie su forni MILLENNIAL TS
standard on MILLENNIAL TS

Innovativo sistema di raffreddamento, che garantisce il funzionamento anche in spazi ristretti, di serie su forni MILLENNIAL TS elettrici

Innovative cooling system, that works perfectly even in narrow spaces, standard on electric ovens MILLENNIAL TS

Blocco porta a 60°, 90°, 120° e 180° di apertura
The opening door system can be locked at 60, 90, 120 and 180 degrees



MODELLO DEPOSITATO
DESIGN APPLICATION

Design minimal ed elegante per un forno professionale che aggrega funzionalità ed innovazioni tecnologiche che vanno sempre nella direzione della miglior qualità del lavoro nelle cucine.

Minimal and elegant design for a professional oven that combines functionality and technological innovations, aspects that always go towards the best quality of kitchen works.

Airflowlogic™





Airflowlogic™ by Tecnoeka è l'innovazione tecnologica brevettata che, grazie ad un carter completamente ridisegnato e ad un profondo studio del ricircolo dell'aria all'interno del forno, permette il raggiungimento di risultati ottimali nell'uniformità di cottura in tutte le aree del forno. L'uniformità grazie a Airflowlogic™ oggi diventa una garanzia per tutti coloro che scelgono l'eccellenza, per tutti coloro che scelgono Millennial.

Canale di aspirazione
Inlet ductwork

Nuova geometria che unisce estetica e funzionalità
New geometry which combines aesthetics and functionality

Uniformità di ventilazione all'interno della camera di cottura
Uniform airflow into the cooking chamber

Configurazione sezioni di aspirazione sia a passo che a geometria variabile per ottimizzare i flussi d'aria nella camera
Different sizes of inlet ductworks in order to optimize the air intake into the cooking chamber

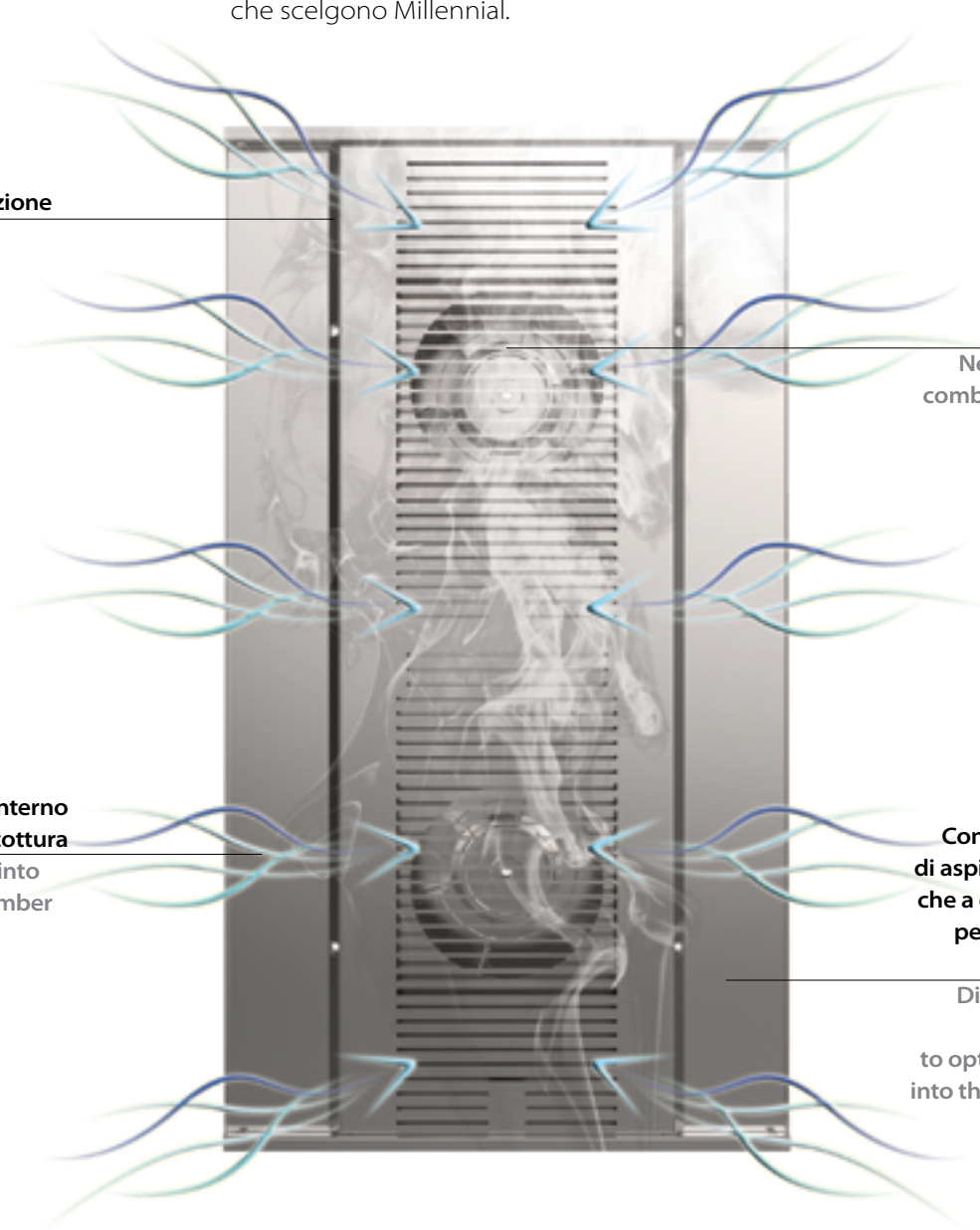

Airflowlogic™ by Tecnoeka is the patented technological innovation that, thanks to a completely redesigned fan guard and a deep study of the air recirculation inside the oven, allows the achievement of optimal cooking uniformity in all the areas of the oven. Thanks to Airflowlogic™, uniformity becomes today a guarantee for all those who choose excellence and all those who choose Millennial.

Humilogic™





Tecnoeka presenta Humilogic™, un nuovo sistema brevettato con l'inserimento di acqua direttamente nella parte posteriore della ventola che garantisce il raggiungimento di alti livelli di umidità in camera di cottura per delle cotture a vapore di qualità e una consistente riduzione dei consumi. Humilogic™, dove il vapore incontra il sapore, mascherandosi nelle forme del cibo, esaltandone la fragranza degli aromi. Humilogic™, l'eccellenza in cucina, per tutti coloro che scelgono Millennial.

Fori per la fuoriuscita dell'acqua

Water output nozzles

Scomposizione in micro particelle d'acqua tramite l'impatto con le pale della ventola

Water contact with in-movement fan blades generates drops nebulization

Vapore generato dal contatto delle particelle d'acqua con il calore della resistenza

Steam generated by the contact of the water particles with the heating elements surface

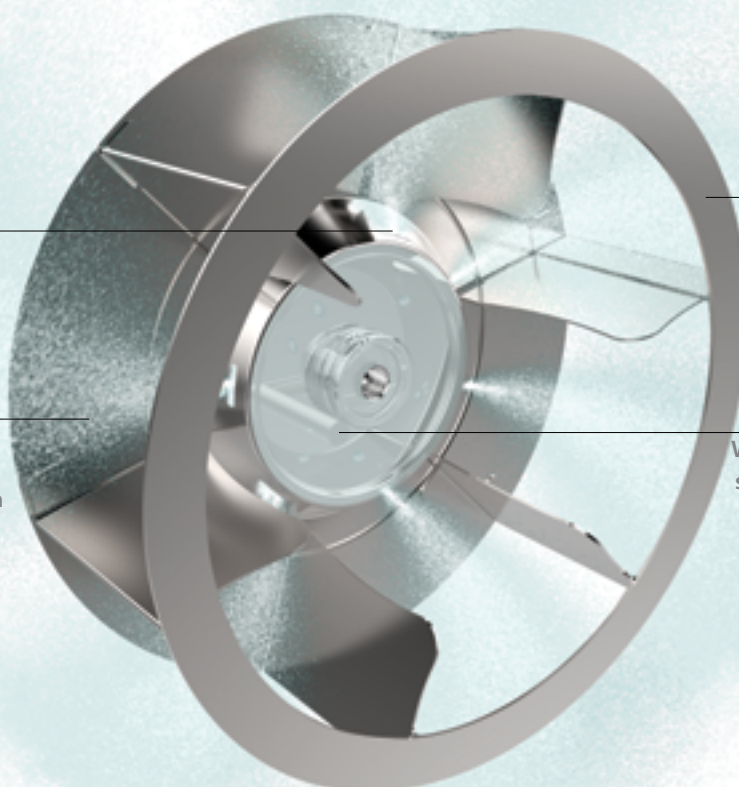

Movimento centrifugo della ventola che permette una distribuzione uniforme dell'acqua

The centrifugal movement of the fan allows the uniform water micro-particles distribution

Introduzione dell'acqua per l'umidificazione dalla parte posteriore della ventola

Water is introduced to the rear side of the fan to humidify the cooking chamber

Tecnoeka presents Humilogic™, a new-patented system with humidification on the rear that ensures high levels of moisture in the cooking chamber for quality steam cooking and a significant reduction of consumption. Humilogic™, where steam meets flavour and blends in the food thus exalting the fragrance of the aromas. Humilogic™, "Excellence in Kitchen" for all those who choose Millennial.

Drylogic™





Con il brevettato sistema di essiccazione rapida della camera di cottura Drylogic™ by Tecnoeka si ottengono cotture eccelse. La tecnologia Drylogic™ opera tramite l'introduzione nel forno di aria prelevata dall'ambiente esterno al fine di ridurre l'umidità presente all'interno della camera di cottura. Attraverso il controllo di specifici parametri predefiniti la linea Millennial ha il pieno controllo nella gestione dell'umidità.

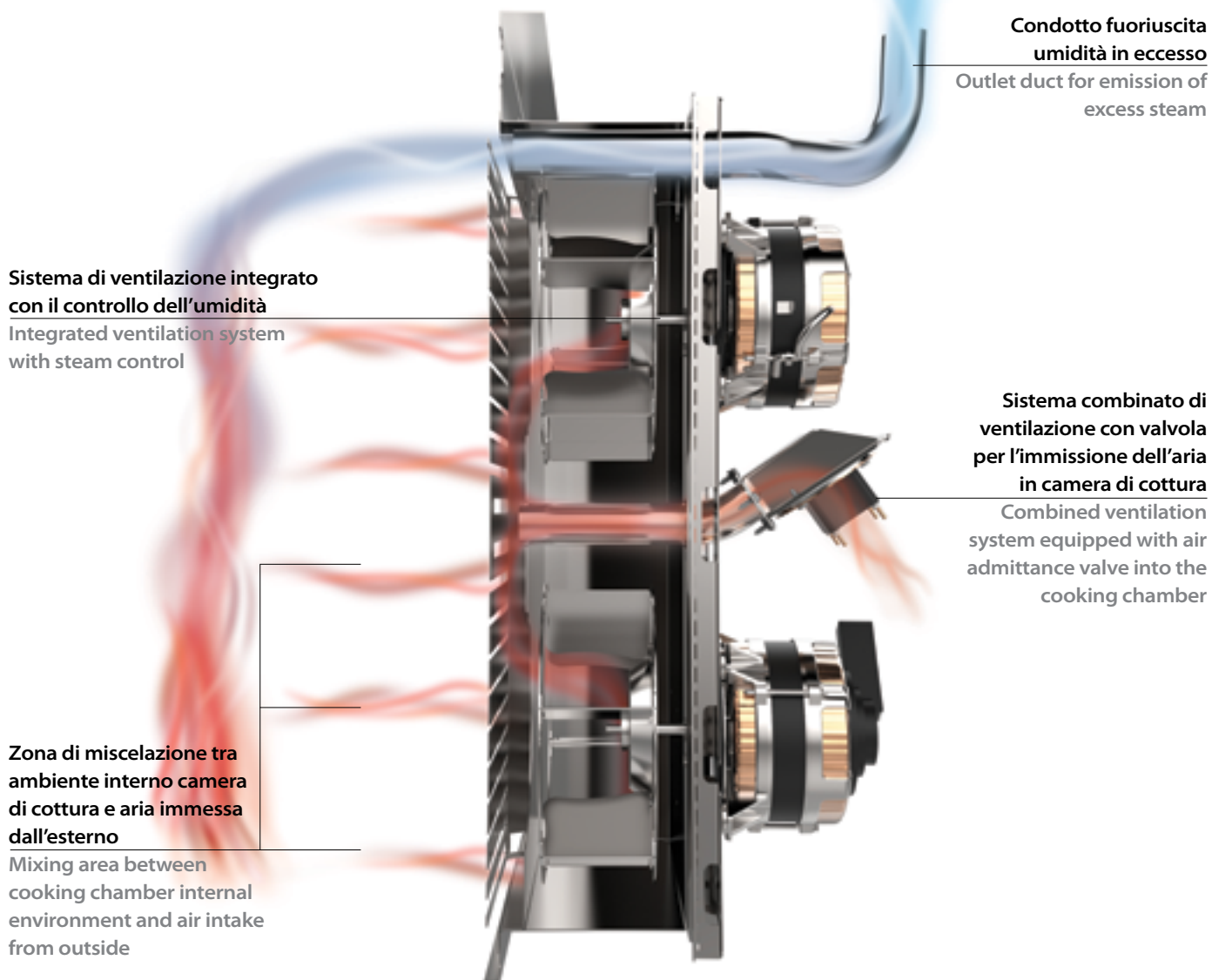

Drylogic™ by Tecnoeka. This new-patented quick-drying system in the cooking chamber allows you to reach excellent cooking. Drylogic™ technological system introduces into the oven air extracted from outside, thus reducing the moisture inside the cooking chamber. Through control of specific predefined parameters, the Millennial line has full control over managing moisture in the cooking chamber.

Sistema di lavaggio

Washing system

4

Sistemi di lavaggio
L1 ECO, L2 NORMALE,
L3 INTENSIVO, R RISCIAQUO
Washing systems
L1 ECO, L2 NORMAL,
L3 INTENSIVE, R RINSE



- 30%

Consumi di acqua
Water consumption

Detergente e brillantante uniti
in un unico prodotto
Detergent and rinse aid combined
in a single product

**Nuovo sistema di lavaggio di serie,
minor ingombro, minor consumi e più efficienza**
New washing system included,
less bulky, less consumptions and more efficiency

Plus

MILLENNIAL

TOUCH SCREEN



30-270 °C

Forni elettrici - Electric ovens

30-260 °C

Forni a gas - Gas ovens

Gestione della temperatura

Temperature management

5

Regolazioni della velocità di ventilazione

Speed fan regulations

Aggiornamento del firmware del forno

Oven firmware update

Gestione programma HACCP

HACCP data management

Software per gestione dell'umidità

Moisture Management Software

Gestione cotture sottovuoto e DELTA T

Vacuum cooking management and DELTA T

Cottura semi statica

Semi static cooking mode

Aggiornamento della documentazione

tecnica e dei manuali

presenti nel forno

Updating of technical documentation and

user manuals in the oven



10

Fasi per ogni ciclo di cottura

Steps for each cooking cycle

Aggiornamento dei ricettari

Recipes update

Modalità di cottura multilivello
che permette di cucinare assieme pietanze
con lo stesso grado di umidificazione e di
temperatura, ma diverso tempo di cottura

Multilevel cooking mode
allows you to cook at the same time different
kind of foods that require the same climax
conditions with different cooking times

**Gestione a 360° delle funzioni,
forno collegabile in rete attraverso connessione Wi-Fi**

360 ° management of functions,
oven connectable via Wi-Fi connection

MILLENNIAL TOUCH SCREEN



- Pannello TFT 7" capacitivo a colori 800x480 touch screen
 - Manopola con funzione scroll e push
- Tre brevetti: **Airflowlogic™**, **Humilogic™**, **Drylogic™**
 - Lavaggio automatico integrato
 - Sonda al cuore multipunto di serie
 - Temperatura forni elettrici da 30 a 270 °C
forni gas da 30 a 260 °C
 - 10 fasi di cottura programmabili
 - Vapore diretto con regolazione automatica attraverso selettore touch screen (10 steps)
 - Preriscaldamento
 - Mantenimento
 - Raffreddamento rapido
 - Camera di cottura in AISI 304
 - Vetro porta ispezionabile
 - Protezione acqua: IPX3, IPX4, IPX5
 - Presa USB
 - Sistema per HACCP
- Vaschetta raccogli condensa con scarico su porta
 - Cerniera con bloccoporta per aperture regolate a 60°, 90°, 120°, 180°
 - Partenza ritardata programmabile fino a 24 h
- Possibilità di comandare cappa, lievitatore e mantenedor
 - Gestione rapida delle ricette di utilizzo più frequenti
 - Ricette programmabili: 500
 - 42 lingue
 - Piedini regolabili
- TFT 7" capacitivo 800x480 color touch screen panel
 - Knob with scroll and push function
- Three patents: **Airflowlogic™**, **Humilogic™**, **Drylogic™**
 - Automatic washing system integrated
 - Multipoint core probe
 - Temperature of electric ovens from 30 to 270 °C
gas ovens from 30 to 260 °C
 - 10 programmable cooking phases
 - Direct steam controlled by touch screen (10 steps)
 - Preheating
 - Holding
 - Cooldown
 - Cooking chamber in AISI 304
 - Inspectionable door glass
 - Protection against water: IPX3, IPX4, IPX5
 - USB socket
 - HACCP system
 - Condensate collection bowl, with drain on door
 - Hinge with door locking for openings adjusted at 60°, 90°, 120°, 180°
 - Delayed start programmable up to 24 h
- Possibility to drive condensation hood and holding cabinet
 - Favorite recipes quick settings
 - Programmable recipes: 500
 - 42 languages
 - Adjustable feet

Pannello TOUCH SCREEN

TOUCH SCREEN panel

- 1 Ora e data - Time and date
- 2 Lista ricette - Recipes list
- 3 Cottura semplificata - Simplified cooking
- 4 Cottura avanzata - Expert cooking
- 5 Ricettario - Recipe book
- 6 Cottura multilivello - Multi-level cooking
- 7 Home
- 8 Accessori - Accessories
- 9 Raffreddamento rapido - Cooldown
- 10 Impostazioni - Settings
- 11 Servizio tecnico - After sales service



MILLENNIAL

BLACK MASK



- Pannello 7" black mask electronic control
 - Due brevetti: **Airflowlogic™, Humilogic™**
 - Semplicità d' utilizzo
 - Temperatura forni elettrici da 30 a 270 °C
forni gas da 30 a 260 °C
 - 10 fasi di cottura programmabili
 - Vapore diretto con regolazione attraverso
selettore pannello black mask (10 steps)
 - Preriscaldamento
 - Mantenimento
 - Raffreddamento rapido
 - Camera di cottura in AISI 304
 - Vetro porta ispezionabile
 - Protezione acqua: IPX3, IPX4
 - Presa USB
 - Sistema per HACCP
 - Predisposizione sonda al cuore
 - Predisposizione al lavaggio automatico
 - Vaschetta raccogli condensa con scarico su porta
 - Cerniera con bloccoporta per aperture
regolate a 60°, 90°, 120°, 180°
 - Partenza ritardata programmabile fino a 24 h
 - Possibilità di comandare cappa, lievitatore e manteneritore
 - Ricette programmabili: 100
 - Piedini regolabili
-
- 7" Black mask electronic control panel
 - Two patents: Airflowlogic™, Humilogic™
 - Easy to use
 - Temperature of electric ovens from 30 to 270 °C
gas ovens from 30 to 260 °C
 - 10 programmable cooking phases
 - Direct steam controlled
by black mask panel (10 steps)
 - Preheating
 - Holding
 - Cooldown
 - Cooking chamber in AISI 304
 - Inspectionable door glass
 - Protection against water: IPX3, IPX4
 - USB socket
 - HACCP system
 - Core probe predisposition
 - Automatic washing system predisposition
 - Condensate collection bowl, with drain on door
 - Hinge with door locking for openings
adjusted at 60°, 90°, 120°, 180°
 - Delayed start programmable up to 24 h
 - Possibility to command the holding cabinet
 - Programmable recipes: 100
 - Adjustable feet

Pannello **BLACK MASK**

BLACK MASK panel

- 1 Preriscaldamento - Preheating
- 2 Mantenimento - Holding
- 3 Raffreddamento rapido - Cooldown
- 4 Sistema di lavaggio - Washing system
- 5 H.A.C.C.P.
- 6 Lievitatore - Proofer
- 7 Mantentore - Holding cabinet
- 8 Allarme cappa - Condensation hood alarm
- 9 Più - Plus
- 10 Meno - Less
- 11 ON/OFF
- 12 Start/Stop

- 13 Cestino - Delete
- 14 Partenza ritardata - Delayed start
- 15 Numero ricetta - Recipe number
- 16 Menù Eka - Eka's recipes
- 17 Menù Chef - Chef's recipes
- 18 Velocità ventole - Speed fans
- 19 Funzione ventola: normale, semistatica, 1/2 potenza
Fan function: normal, semi-static, 1/2 power
- 20 Sonda al cuore - Core probe
- 21 ΔT
- 22 Temperatura sonda - Core temperature
- 23 Vapore - Steam
- 24 Temperatura - Temperature
- 25 USB
- 26 Tempo di cottura - Time of cooking
- 27 Fase di cottura - Cooking step
- 28 Ora e data - Time and date

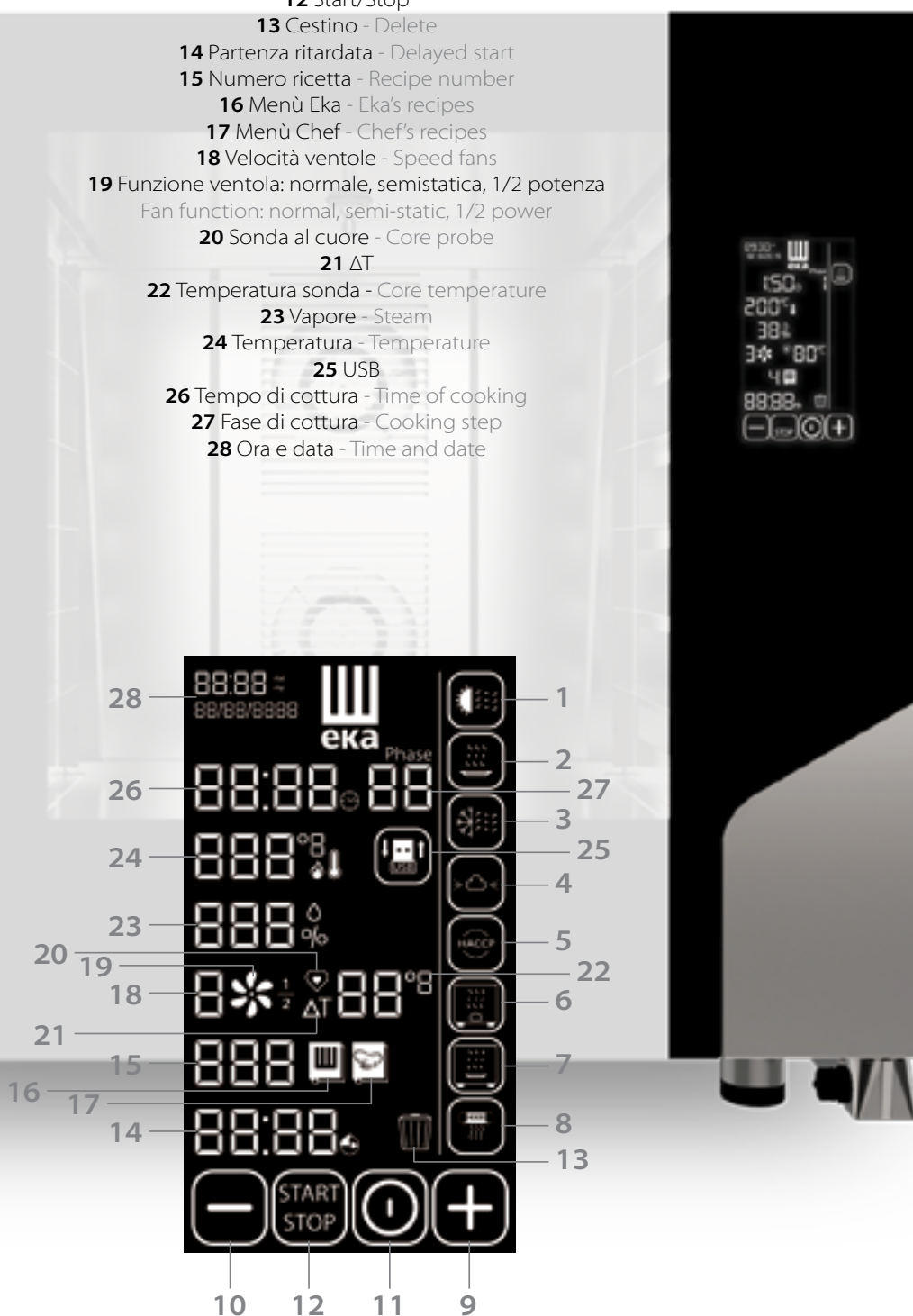

MILLENNIAL

SMART



- Pannello elettromeccanico
- Semplicità d' utilizzo
- Timer per cottura da 10 a 120 minuti / infinito
- Temperatura forni elettrici da 100 a 270 °C
- forni gas da 100 a 260 °C
- Vapore diretto con regolazione attraverso selettore a manopola (5 steps)
- Camera di cottura in AISI 304
- Vetro porta ispezionabile
- Protezione acqua: IPX3, IPX4
- Predisposizione al lavaggio manuale
- Certificazione CB
- Vaschetta raccogli condensa con scarico su porta
- Cerniera con bloccoporta per aperture regolate a 60°, 90°, 120°, 180°
- Piedini regolabili

- Electromechanic panel
- Easy to use
- Timer for cooking from 10 to 120 minutes / infinity
- Temperature of electric ovens from 100 to 270 °C
- gas ovens from 100 to 260 °C
- Direct steam controlled by knob (5 steps)
- Cooking chamber in AISI 304
- Inspectable door glass
- Protection against water: IPX3, IPX4
- Manual washing predisposition
- CB certification
- Condensate collection bowl, with drain on door
- Hinge with door locking for openings adjusted at 60°, 90°, 120°, 180°
- Adjustable feet

Pannello **SMART**

SMART panel

- 1 Tempo - Time
- 2 Temperatura - Temperature
- 3 Vapore - Steam







MILLENNIAL **Bakery & Pastry**



MKF 464

Forno combinato convezione
vapore 4 teglie 600 x 400 mm
Combi oven 4 trays 600 x 400 mm

SMART

MKF 464 S



BLACK MASK

MKF 464 BM

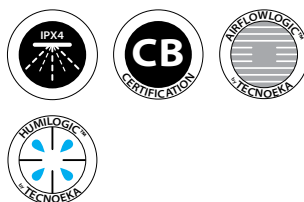

TOUCH SCREEN

MKF 464 TS



Alimentazione Power	Elettrico Electricity ⚡	Elettrico Electricity ⚡	Elettrico Electricity ⚡
Numero pasti Number of meals	72 - 120	72 - 120	72 - 120
Numero teglie Number of trays	4	4	4
Dimensioni teglia Tray dimension	600 x 400 mm	600 x 400 mm	600 x 400 mm
Passo guide Rack rails distance	80 mm	80 mm	80 mm
Temperatura Temperature	100 - 270 °C	30 - 270 °C	30 - 270 °C
Potenza - Portata termica Power supp.-Thermal supp.	7,8 kW	7,8 kW	7,8 kW
Voltaggio Voltage	AC 380/400 3N	AC 380/400 3N	AC 380/400 3N
Frequenza Frequency	50 Hz (60 su richiesta) 50 Hz (60 on demand)	50/60 Hz	50/60 Hz
Pannello comandi Control panel	Elettromeccanico Electromechanic	Black mask electronic control	Touch screen
N. Programmi N. programs	/	100	500
Lavaggio automatico Automatic washing	/	Su richiesta On demand	Incluso Included
Sonda al cuore Core probe	/	Su richiesta On demand	Inclusa MKSCMU/A Included MKSCMU/A
Dimensioni (LxPxH) Dimensions (WxDxH)	850 x 1044 x 700 mm	850 x 1035 x 700 mm	850 x 1035 x 700 mm
Peso Weight	92,4 kg	92,4 kg	92,4 kg

TOUCH SCREEN
SMART
BLACK MASK
TOUCH SCREEN
MKF 4642 TS



Con 2 motori
With 2 motors



Elettrico
Electricity

MKF 464 G S

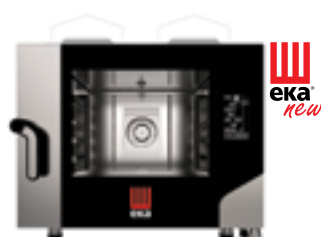
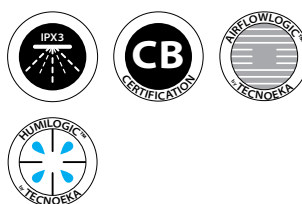
Gas

MKF 464 G BM

Gas

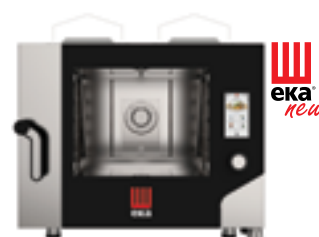
MKF 464 G TS

Gas

72 - 120	72 - 120	72 - 120	72 - 120
4	4	4	4
600 x 400 mm	600 x 400 mm	600 x 400 mm	600 x 400 mm
80 mm	80 mm	80 mm	80 mm
30 - 270 °C	100 - 260 °C	30 - 260 °C	30 - 260 °C
8,3 kW	9,3 kW	9,3 kW	9,3 kW
AC 380/400 3N	AC 220/230	AC 220/230	AC 220/230
50/60 Hz	50 Hz (60 su richiesta) 50 Hz (60 on demand)	50/60 Hz	50/60 Hz
Touch screen	Elettromeccanico Electromechanic	Black mask electronic control	Touch screen
500	/	100	500
Incluso Included	/	Su richiesta On demand	Incluso Included
Inclusa MKSCMU/A Included MKSCMU/A	/	Su richiesta On demand	Inclusa MKSCMU/A Included MKSCMU/A
850 x 1035 x 700 mm	850 x 1041 x 801 mm	850 x 1035 x 801 mm	850 x 1035 x 800 mm
97 kg	102 kg	102 kg	102 kg

MKF 664

Forno combinato convezione
vapore 6 teglie 600 x 400 mm
Combi oven 6 trays 600 x 400 mm

SMART

MKF 664 S P



Senza vapore
Without steam



SMART

MKF 664 S



BLACK MASK

MKF 664 BM

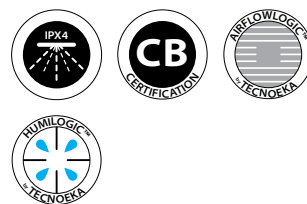

Alimentazione Power	Elettrico Electricity ⚡	Elettrico Electricity ⚡	Elettrico Electricity ⚡
Numero pasti Number of meals	108 - 180	108 - 180	108 - 180
Numero teglie Number of trays	6	6	6
Dimensioni teglia Tray dimension	600 x 400 mm	600 x 400 mm	600 x 400 mm
Passo guide Rack rails distance	80 mm	80 mm	80 mm
Temperatura Temperature	100 - 270 °C	100 - 270 °C	30 - 270 °C
Potenza - Portata termica Power supp.-Thermal supp.	10,4 kW	10,4 kW	10,4 kW
Voltaggio Voltage	AC 380/400 3N	AC 380/400 3N	AC 380/400 3N
Frequenza Frequency	50 Hz (60 su richiesta) 50 Hz (60 on demand)	50 Hz (60 su richiesta) 50 Hz (60 on demand)	50/60 Hz
Pannello comandi Control panel	Elettromeccanico Electromechanic	Elettromeccanico Electromechanic	Black mask electronic control
N. Programmi N. programs	/	/	100
Lavaggio automatico Automatic washing	/	/	Su richiesta On demand
Sonda al cuore Core probe	/	/	Su richiesta On demand
Dimensioni (LxPxH) Dimensions (WxDxH)	850 x 1041 x 850 mm	850 x 1041 x 850 mm	850 x 1035 x 850 mm
Peso Weight	108,2 kg	108,2 kg	108,2 kg

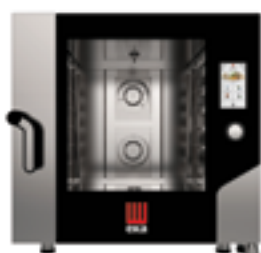
TOUCH SCREEN
SMART
BLACK MASK
TOUCH SCREEN
MKF 664 TS

 Elettrico

 Electricity

MKF 664 G S

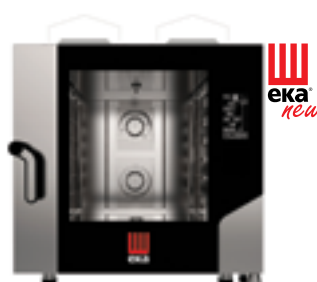
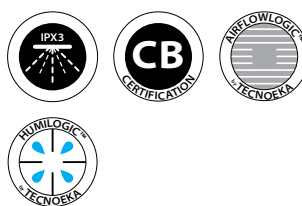
Gas

MKF 664 G BM

Gas

MKF 664 G TS

Gas

108 - 180

108 - 180

108 - 180

108 - 180

6

6

6

6

600 x 400 mm

600 x 400 mm

600 x 400 mm

600 x 400 mm

80 mm

80 mm

80 mm

80 mm

30 - 270 °C

100 - 260 °C

30 - 260 °C

30 - 260 °C

11,4 kW

13,5 kW

13,5 kW

13,5 kW

AC 380/400 3N

AC 220/230

AC 220/230

AC 220/230

50/60 Hz

 50 Hz (60 su richiesta)
 50 Hz (60 on demand)

50/60 Hz

50/60 Hz

Touch screen

 Elettromeccanico
 Electromechanic

 Black mask
 electronic control

Touch screen

500

/

100

500

 Incluso
 Included

/

 Su richiesta
 On demand

 Incluso
 Included

 Inclusa MKSCMU/A
 Included MKSCMU/A

/

 Su richiesta
 On demand

 Inclusa MKSCMU/A
 Included MKSCMU/A

850 x 1035 x 850 mm

850 x 1041 x 951 mm

850 x 1035 x 951 mm

850 x 1035 x 950 mm

108,2 kg

123 kg

123 kg

123 kg

MKF 1064

Forno combinato convezione
vapore 10 teglie 600 x 400 mm
Combi oven 10 trays 600 x 400 mm

SMART

MKF 1064 S



Elettrico
Electricity ⚡

BLACK MASK

MKF 1064 BM



Elettrico
Electricity ⚡

Alimentazione

Power

Numero pasti

Number of meals

Numero teglie

Number of trays

Dimensioni teglia

Tray dimension

Passo guide

Rack rails distance

Temperatura

Temperature

Potenza - Portata termica

Power supply - Thermal supply

Voltaggio

Voltage

Frequenza

Frequency

Pannello comandi

Control panel

N. Programmi

N. programs

Lavaggio automatico

Automatic washing

Sonda al cuore

Core probe

Dimensioni (LxPxH)

Dimensions (WxDxH)

Peso

Weight

180 - 300

180 - 300

10

10

600 x 400 mm

600 x 400 mm

80 mm

80 mm

100 - 270 °C

30 - 270 °C

15,4 kW

15,4 kW

AC 380/400 3N

AC 380/400 3N

50 Hz (60 su richiesta)
50 Hz (60 on demand)

50/60 Hz

Elettromeccanico
Electromechanic

Black mask
electronic control

/

100

/

Su richiesta
On demand

/

Su richiesta
On demand

850 x 1041 x 1130 mm

850 x 1035 x 1130 mm

140,4 kg

140,4 kg

TOUCH SCREEN
SMART
BLACK MASK
TOUCH SCREEN
MKF 1064 TS

 Elettrico
Electricity ⚡

MKF 1064 G S

Gas 🔥

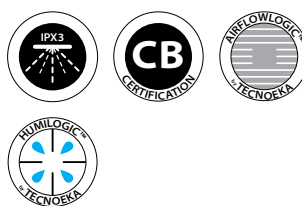
MKF 1064 G BM

Gas 🔥

MKF 1064 G TS

Gas 🔥

180 - 300	180 - 300	180 - 300	180 - 300
10	10	10	10
600 x 400 mm	600 x 400 mm	600 x 400 mm	600 x 400 mm
80 mm	80 mm	80 mm	80 mm
30 - 270 °C	100 - 260 °C	30 - 260 °C	30 - 260 °C
17 kW	18 kW	18 kW	18 kW
AC 380/400 3N	AC 220/230	AC 220/230	AC 220/230
50/60 Hz	50 Hz (60 su richiesta) 50 Hz (60 on demand)	50/60 Hz	50/60 Hz
Touch screen	Elettromeccanico Electromechanic	Black mask electronic control	Touch screen
500	/	100	500
Incluso Included	/	Su richiesta On demand	Incluso Included
Inclusa MKSCMU/A Included MKSCMU/A	/	Su richiesta On demand	Inclusa MKSCMU/A Included MKSCMU/A
850 x 1035 x 1130 mm	850 x 1041 x 1231 mm	850 x 1035 x 1231 mm	850 x 1035 x 1230 mm
140,4 kg	158 kg	158 kg	158 kg

MKF 1664

Forno combinato convezione
vapore 16 teglie 600 x 400 mm
Combi oven 16 trays 600 x 400 mm

SMART

MKF 1664 S

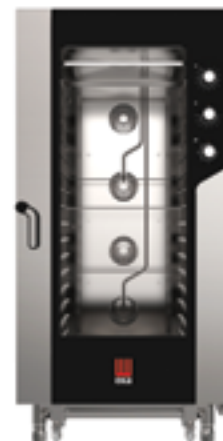

Elettrico
Electricity 

Alimentazione Power	
Numero pasti Number of meals	288 - 480
Numero teglie Number of trays	16
Dimensioni teglia Tray dimension	600 x 400 mm
Passo guide Rack rails distance	80 mm
Temperatura Temperature	100 - 270 °C
Potenza - Portata termica Power supply - Thermal supply	31 kW
Voltaggio Voltage	AC 380/400 3N
Frequenza Frequency	50 Hz (60 su richiesta) 50 Hz (60 on demand)
Pannello comandi Control panel	Elettromeccanico Electromechanic
N. Programmi N. programs	/
Lavaggio automatico Automatic washing	/
Sonda al cuore Core probe	/
Dimensioni (LxPxH) Dimensions (WxDxH)	930 x 1035 x 1900 mm
Peso Weight	247,2 kg

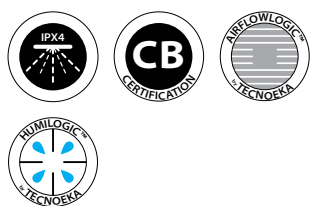
BLACK MASK
TOUCH SCREEN
BLACK MASK
TOUCH SCREEN
MKF 1664 BM
MKF 1664 TS
MKF 1664 G BM
MKF 1664 G TS

 Elettrico
Electricity ⚡

 Elettrico
Electricity ⚡

Gas 🔥

Gas 🔥

DECK

Forno DECK elettrico con vapore 600 x 400 mm

Electric DECK oven 600 x 400 mm with steam

Alimentazione

Power

Numero teglie

Number of trays

Dimensioni teglia

Tray dimension

Temperatura

Temperature

Potenza

Power supply

Voltaggio

Voltage

Frequenza

Frequency

Pannello comandi

Control panel

N. Programmi

N. programs

Lavaggio automatico

Automatic washing

Sonda al cuore

Core probe

Dimensioni (LxPxH)

Dimensions (WxDxH)

Peso

Weight

DECK

MKF D1T



Elettrico 
Electricity

1

600 x 400 mm

30 - 350 °C

2,8 kW

AC 220/230

50/60 Hz

Touch control

50

/

/

850 x 980 x 435 mm

65 kg

DECK

MKF D2T



Elettrico 
Electricity

2

600 x 400 mm

30 - 350 °C

5,5 kW

AC 380/400 3N

50/60 Hz

Touch control

50

/

/

850 x 1250 x 435 mm

85 kg

Lievitatori e mantenitori Proofers and holding cabinets





MKL 1064 S

Lievitatore elettrico per forni 4, 6 e 10 teglie S e
forno DECK 1 teglia

Electric proofer for 4, 6 and 10 trays ovens S and
1 tray DECK oven



Numero teglie Number of trays	10
Dimensioni teglia Tray dimension	600 x 400 mm
Passo guide Rack rails distance	85 mm
Temperatura lievitatore Temperature of proofer	25 - 65 °C
Potenza Power supply	2,4 kW
Voltaggio Voltage	AC 220/230
Frequenza Frequency	50/60 Hz
Dimensioni (LxPxH) Dimensions (WxDxH)	850 x 1030 x 770 mm
Peso Weight	91 kg



MKLM 1064

Lievitatore e mantenitore elettrico
per forni 4, 6 e 10 teglie BM e TS, comandato dal forno
Electric proofer and holding cabinet
for 4, 6 and 10 trays BM and TS ovens, controlled by the oven



Numero teglie Number of trays	10
Dimensioni teglia Tray dimension	600 x 400 mm
Passo guide Rack rails distance	85 mm
Temperatura lievitatore Temperature of proofer	20 - 40 °C
Temperatura mantenitore Temperature of holding cabinet	65 - 85 °C
Potenza Power supply	1,8 kW
Voltaggio Voltage	AC 220/230
Frequenza Frequency	50/60 Hz
Dimensioni (LxPxH) Dimensions (WxDxH)	850 x 1030 x 770 mm
Peso Weight	91 kg



eKa

Cappe

Condensation hoods



MKKC 4

Cappa elettrica di aspirazione a condensazione
per forni 4 teglie BM e TS, comandata dal forno

Electric condensation hood for 4 trays
BM and TS ovens, controlled by the oven



Disponibile **MKKC 4 S** per forni 4 teglie S (MKF 464 S)

MKKC 4 S available for 4 trays S ovens (MKF 464 S)



Potenza Power supply	0,6 kW
Voltaggio Voltage	AC 220/230
Frequenza Frequency	50/60 Hz
Dimensioni (LxPxH) Dimensions (WxDxH)	850 x 1045 x 308 mm
Peso Weight	29 kg

MKKC 610

Cappa elettrica di aspirazione a condensazione
per forni 6 e 10 teglie BM e TS, comandata dal forno

Electric condensation hood for 6 and 10 trays
BM and TS ovens, controlled by the oven

Disponibile **MKKC 610 S** per forni 6 e 10 teglie S
(MKF 664 S, MKF 621 S, MKF 1064 S e MKF 1021 S)

MKKC 610 S available for 6 and 10 trays S ovens
(MKF 664 S, MKF 621 S, MKF 1064 S and MKF 1021 S)



Potenza Power supply	0,6 kW
Voltaggio Voltage	AC 220/230
Frequenza Frequency	50/60 Hz
Dimensioni (LxPxH) Dimensions (WxDxH)	850 x 1045 x 308 mm
Peso Weight	29 kg

MKKC 1620

Cappa elettrica di aspirazione a condensazione
per forni 16 e 20 teglie BM e TS, comandata dal forno

Electric condensation hood for 16 and 20 trays
BM and TS ovens, controlled by the oven

Disponibile **MKKC 1620 S** per forni 16 e 20 teglie S
(MKF 1664 S e MKF 2011 S)



MKKC 1620 S available for 16 and 20 trays S ovens
(MKF 1664 S and MKF 2011 S)



Potenza Power supply	0,6 kW
Voltaggio Voltage	AC 220/230
Frequenza Frequency	50/60 Hz
Dimensioni (LxPxH) Dimensions (WxDxH)	930 x 1045 x 308 mm
Peso Weight	31,4 kg

Tavoli e carrelli

Tables and trolleys

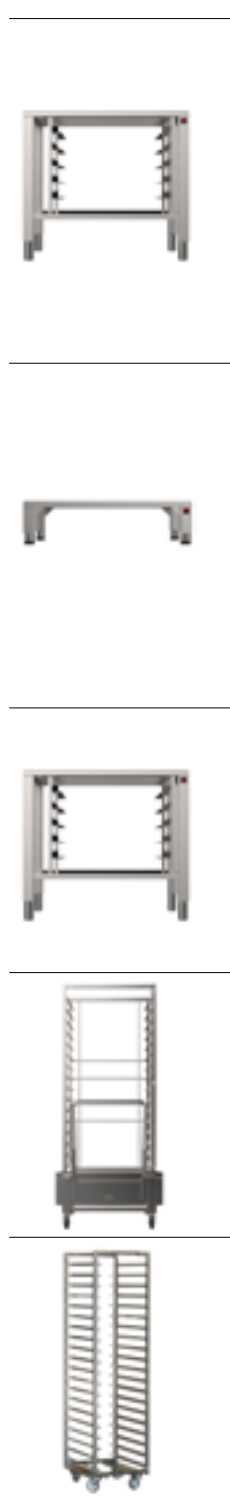
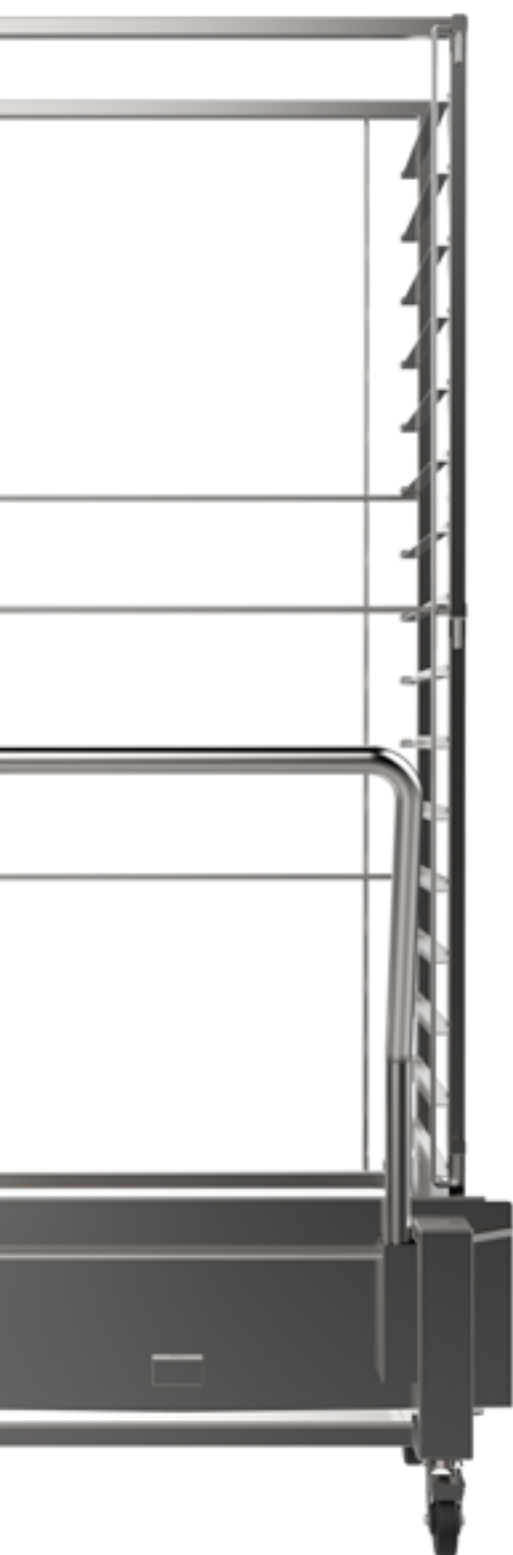



Tavolo fisso in AISI 430 con supporti, per forni 4 - 6 - 10 teglie e forno DECK 1 teglia
 per MKF 464 con kit sovrapposizione forni con supporti teglie MKSST 464;
 per MKF 664 con kit sovrapposizione forni MKST 664;
 per MKF 1064 con kit sovrapposizione forni MKS 64;
 per MKF D1T con kit sovrapposizione forni MKS 64

MKTS 64

AISI 430 fixed table with supports, for ovens 4 - 6- 10 trays and 1 tray DECK oven
 for MKF 464 with kit for overlapping ovens with tray supports MKSST 464;
 for MKF 664 with kit for overlapping oven MKST 664;
 for MKF 1064 with kit for overlapping ovens MKS 64;
 for MKF D1T with kit for overlapping ovens MKS 64
 850 x 787 x 770 mm
 per mod - for mod: MKF 464, MKF 664, MKF 1064, MKF D1T

Tavolo fisso in AISI 430 per forni 4 - 6 - 10 teglie
 (per sovrapposizione forni),
 per MKF 464 con kit sovrapposizione forni con supporti teglie MKSST 464;
 per MKF 664 e MKF 621 con kit sovrapposizione forni MKS 64;
 per MKF 1064 e MKF 1021 con kit sovrapposizione forni MKS 64

MKT 64 D

AISI 430 fixed table, for ovens 4 - 6- 10 trays
 (for overlapping ovens),
 for MKF 464 with kit for overlapping ovens with tray supports MKSST 464;
 for MKF 664 and MKF 621 with kit for overlapping oven MKS 64;
 for MKF 1064 and MKF 1021 with kit for overlapping oven MKS 64
 850 x 787 x 220 mm
 per mod - for mod: MKF 464, MKF 664, MKF 1064, MKF 621, MKF 1021

Tavolo fisso in AISI 430 con supporti,
 per MKF D2T con kit sovrapposizione forni MKS 64

MKTSD 2T

AISI 430 fixed table with supports,
 for MKF D2T with kit for overlapping oven MKS 64
 850 x 1060 x 770 mm
 per mod - for mod: MKF D2T

Carrello estraibile in AISI 304, con impugnatura ergonomica
 asportabile e ruote frenanti, per forni 16 teglie

EKCR 16 TC

AISI 304 pull-out trolley with removable
 handle and braked wheels, for 16 trays ovens
 740 x 560 x 1704 mm
 per mod - for mod: MKF 1664

EKCR 1664

Carrello porta-teglie 600x400 mm in acciaio inox
 di servizio con 16 ripiani passo 100 mm,
 non inseribile in camera di cottura
 Stainlees steel tray transport trolley 600x400 mm
 16 shelves service trolley - pitch distance 100 mm
 not to insert in the cooking chamber
 460 x 620 x 1800 mm

Complementi

Optionals



EKKD

Kit doccia completo di supporto doccia,
tubo e relativa predisposizione
per mod: tutti i forni millennial tranne MKF 664 SP, MKF D1T e MKF D2T

Spray kit with support and tube
for mod: all millennial ovens except MKF 664 SP, MKF D1T and MKF D2T



MKSCMO

Sonda al cuore monopunto
per mod: tutti i forni millennial TS

Single-point core probe
for mod: all TS millennial ovens



MKSCMU/A

Sonda al cuore multipunto (3 punti)
per mod: tutti i forni millennial TS

Multi-point core probe (3 points)
for mod: all TS millennial ovens



MKSCSV

Sonda al cuore cottura "sottovuoto"
per mod: tutti i forni millennial TS

Vacuum cooking core probe
for mod: all TS millennial ovens



MKSSC/A

Supporto sonda al cuore
per mod: tutti i forni millennial TS

Support for core probe
for mod: all TS millennial ovens



EKSCS

Sonda al cuore con supporto
per mod: tutti i forni millennial BM

Core probe with support
for mod: all BM millennial ovens



MKAF

Affumicatore
per mod: tutti i forni millennial

Smoker
for mod: all millennial ovens



MKBZ

Buzzer potenziato per forni millennial
per mod: tutti i forni millennial TS

Boosted buzzer for millennial ovens
for mod: all TS millennial ovens



MKWT

Sistema di lavaggio automatico
per mod: tutti i forni millennial BM

Automatic washing system
for mod: all BM millennial ovens



MKDET

Detergente e brillantante
per mod: tutti i forni millennial TS e BM

Detergent and rinse aid
for mod: all TS and BM millennial ovens
12 kg



MKDETS

Detergente e brillantante
per mod: tutti i forni millennial TS e BM

Detergent and rinse aid
for mod: all TS and BM millennial ovens
6 kg



KAF

Addolcitore LT.8
capacità: 1000 Lt/h
per mod: tutti i forni millennial tranne MKF 664 SP

Water softener LT.8
capacity: 1000 Lt/h
for mod: all millennial ovens except MKF 664 S P

Complementi

Optionals



KTA

Testata di connessione
cartuccia filtrante per trattamento acqua potabile
per mod: tutti i forni millennial tranne MKF 664 SP

Filter head for water optimisation
for mod: all millennial ovens except MKF 664 S P



KCA

Cartuccia filtrante per trattamento acqua potabile
per mod: tutti i forni millennial tranne MKF 664 SP

Filter for water optimisation
for mod: all millennial ovens except MKF 664 S P



MKKR

Kit ruote
(2 ruote piroettanti con freno, 2 ruote piroettanti senza freno)

Set of wheels
(2 rotating wheels with brake, 2 rotating wheels without brake)
H 110 mm

per mod - for mod: MKTS 11, MKTS 623 C, MKTS 11 C, MKTS 64, MKTS 21



MKKPI

Kit prima installazione per forni millennial TS, BM e S (non compatti)
First installation kit for millennial TS, BM and S ovens (no compact ovens)



MKCKIT

Kit cappa Millennial per forni TS e BM sovrapposti
per mod: tutte le cappe dei forni millennial TS e BM
tranne MKKC 1620

Millennial condensation hood kit for overlapped ovens
for mod: all condensation hoods for millennial TS e BM ovens
except MKKC 1620



MKCSKIT

Kit cappa Millennial per forni S sovrapposti
per mod: tutte le cappe dei forni millennial S
tranne MKKC 1620 S

Millennial condensation hood kit for overlapped ovens
for mod: all condensation hoods for millennial S ovens
except MKKC 1620 S



MKS 64

Kit sovrapposizione forni in AISI 430 H 55 mm
 per sovrapposizione MKF 464 a MKF 464, MKF 1064 oppure a MKF D1T;
 per sovrapposizione MKF 664 o MKF 621 a MKF 664, MKF 621, MKF D1T oppure a MKT 64 D;
 per sovrapposizione MKF 1064 a MKLM 1064, MKL 1064 S o a MKT 64 D oppure a MKTS 64;
 per sovrapposizione MKF D1T a MKTS 64, MKLM 1064 oppure a MKL 1064 S;
 per sovrapposizione MKF D2T a MKTSD 2T;
 per sovrapposizione MKF 1021 a MKT 64 D oppure a MKTS 21

AISI 430 kit for overlapping ovens H 55 mm
 for overlapping MKF 464 with MKF 464, MKF 1064 or with MKF D1T;
 for overlapping MKF 664 or MKF 621 with MKF 664, MKF 621, MKF D1T or with MKT 64 D;
 for overlapping MKF 1064 with MKLM 1064, MKL 1064 S, MKT 64 D or with MKTS 64;
 for overlapping MKF D1T with MKTS 64, MKLM 1064 or with MKL 1064 S;
 for overlapping MKF D2T with MKTSD 2T;
 for overlapping MKF 1021 with MKT 64 D or with MKTS 21
 per mod - for mod: MKF 464, MKF 664, MKF 1064, MKF D1T, MKF D2T, MKF 621 MKF 1021



MKST 664

Kit sovrapposizione forni in AISI 430 H 180 mm
 per sovrapposizione MKF 664 a MKLM 1064, MKL 1064 S oppure a MKTS 64;
 per sovrapposizione MKF 621 a MKTS 21

AISI 430 kit for overlapping ovens H 180 mm
 for overlapping MKF 664 with MKLM 1064, MKL 1064 S or with MKTS 64;
 for overlapping MKF 621 with MKTS 21
 per mod - for mod: MKF 664, MKF 621



MKSST 464

Kit sovrapposizione forni con supporti teglie in AISI 430, capacità 3 teglie 600 x 400 mm
 per sovrapposizione MKF 464 a MKLM 1064, MKL 1064 S
 o a MKT 64 D oppure a MKTS 64

AISI 430 kit for overlapping ovens with trays supports, capacity of 3 trays 600 x 400 mm
 for overlapping MKF 464 with MKLM 1064, MKL 1064 S
 or MKT 64 D or with MKTS 64
 per mod - for mod: MKF 464



MKSBX416

Kit supporti laterali bivalenti dx/sx in AISI 304
 capacità 4 teglie 600 x 400 mm o 1/1 GN

AISI 304 dual-support kit right/left
 capacity 4 trays 600 x 400 mm or 1/1 GN
 per mod - for mod: MKF 464, MKF 416



MKSBX616

Kit supporti laterali bivalenti dx/sx in AISI 304
 capacità 6 teglie 600 x 400 mm o 1/1 GN

AISI 304 dual-support kit right/left
 capacity 6 trays 600 x 400 mm or 1/1 GN
 per mod - for mod: MKF 664, MKF 616



MKSBX1016

Kit supporti laterali bivalenti dx/sx in AISI 304
 capacità 10 teglie 600 x 400 mm o 1/1 GN

AISI 304 dual-support kit right/left
 capacity 10 trays 600 x 400 mm or 1/1 GN
 per mod - for mod: MKF 1064, MKF 1016

Teglie e griglie

Trays and grids

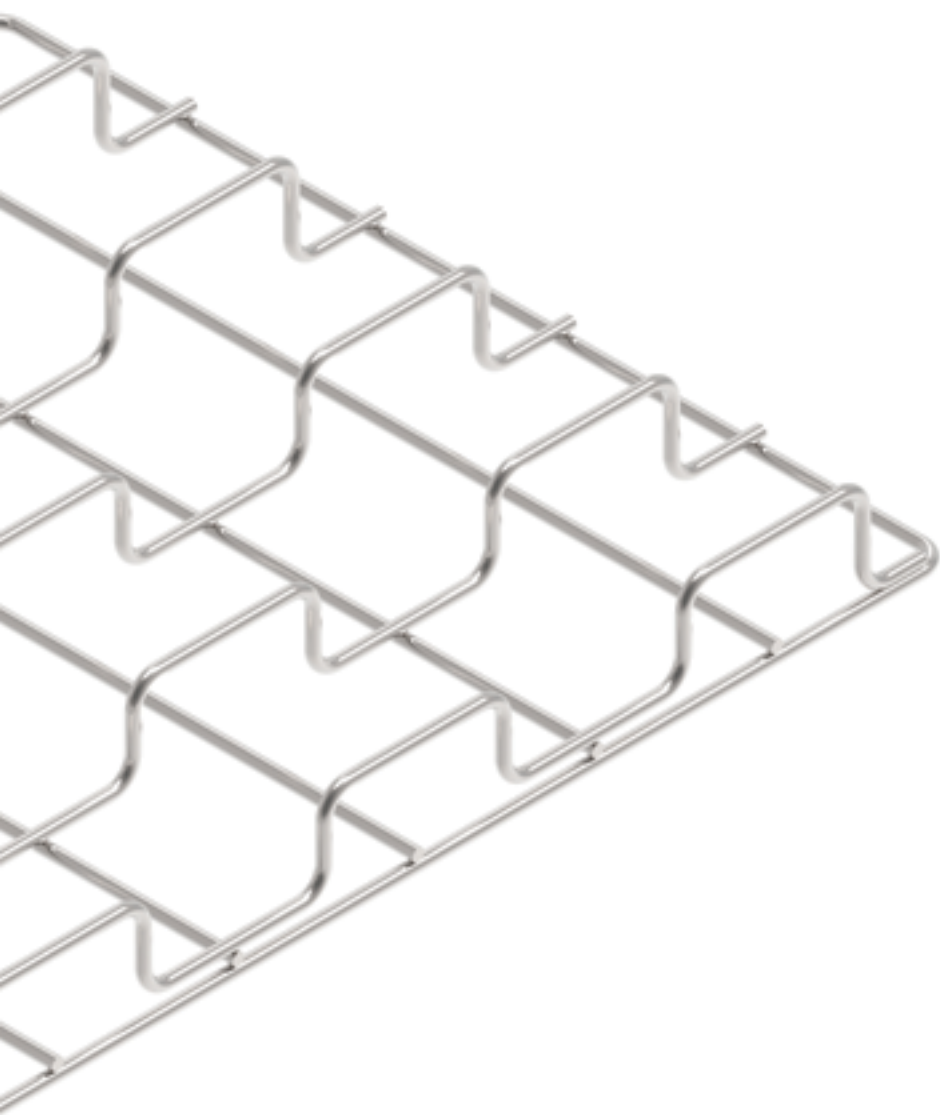



Teglie e griglie per forni 600 x 400 mm
Trays and grids for 600 x 400 mm ovens

**FOOD CONTACT
 CERTIFICATE**



	KT9P/A	<p>Teglia in alluminio per mod: tutti i forni millennial 600 x 400 mm e tutti i forni deck Aluminium tray for mod: all millennial ovens 600 x 400 mm and all deck ovens (max 210 °C) 600 x 400 x 20 mm</p>
	KT9P/B	<p>Teglia in alluminio con fondo diamantato per mod: tutti i forni millennial 600 x 400 mm e tutti i forni deck Aluminium tray with diamond bottom for mod: all millennial ovens 600 x 400 mm and all deck ovens (max 210 °C) 600 x 400 x 20 mm</p>
	KTF8P/A	<p>Teglia in alluminio forata per mod: tutti i forni millennial 600 x 400 mm Perforated aluminium tray for mod: all millennial ovens 600 x 400 mm 600 x 400 x 20 mm</p>
	KTF8PT/A	<p>Teglia in alluminio forata con rivestimento in teflon per mod: tutti i forni millennial 600 x 400 mm Perforated aluminium tray teflon coated for mod: all millennial ovens 600 x 400 mm 600 x 400 x 20 mm</p>
	KG9P	<p>Griglia cromata per mod: tutti i forni millennial 600 x 400 mm Chromed grid for mod: all millennial ovens 600 x 400 mm 600 x 400 x 13 mm</p>
	KG9PX	<p>Griglia in AISI 304 per mod: tutti i forni millennial 600 x 400 mm AISI 304 grid for mod: all millennial ovens 600 x 400 mm 600 x 400 x 13 mm</p>
	KTF9P	<p>Teglia in alluminio forata a 5 canali ondulata per mod: tutti i forni millennial 600 x 400 mm 5 lanes perforated and corrugated aluminium tray for mod: all millennial ovens 600 x 400 mm 600 x 400 x 37 mm</p>
	KTF9PT	<p>Teglia in alluminio forata a 5 canali ondulata con rivestimento in teflon per mod: tutti i forni millennial 600 x 400 mm 5 lanes perforated and corrugated aluminium tray teflon coated for mod: all millennial ovens 600 x 400 mm 600 x 400 x 37 mm</p>
	KG5CPX	<p>Griglia in AISI 304 a 5 canali per mod: tutti i forni millennial 600 x 400 mm 5 lanes AISI 304 grid for mod: all millennial ovens 600 x 400 mm 600 x 400 x 50 mm</p>
	KPP64	<p>Piastra multifunzione in alluminio alimentare per mod: tutti i forni millennial 600 x 400 mm Uncoated food aluminium plate for mod: all millennial ovens 600 x 400 mm 600 x 400 x 20 mm</p>
	EKT64RG	<p>Teglia in AISI 304 raccogli grasso AISI 304 fat drip pan 604,4 x 420 x 40,3 per mod - for mod: MKF 464, MKF 664, MKF 1064</p>
	KGP64/A	<p>Griglia in AISI 304 per cottura verticale di nr. 10 polli AISI 304 vertical cooking pan for 10 chicken 600 x 400 x 148,1 mm per mod - for mod: MKF 464, MKF 664, MKF 1064</p>

Modular design 600 x 400 mm

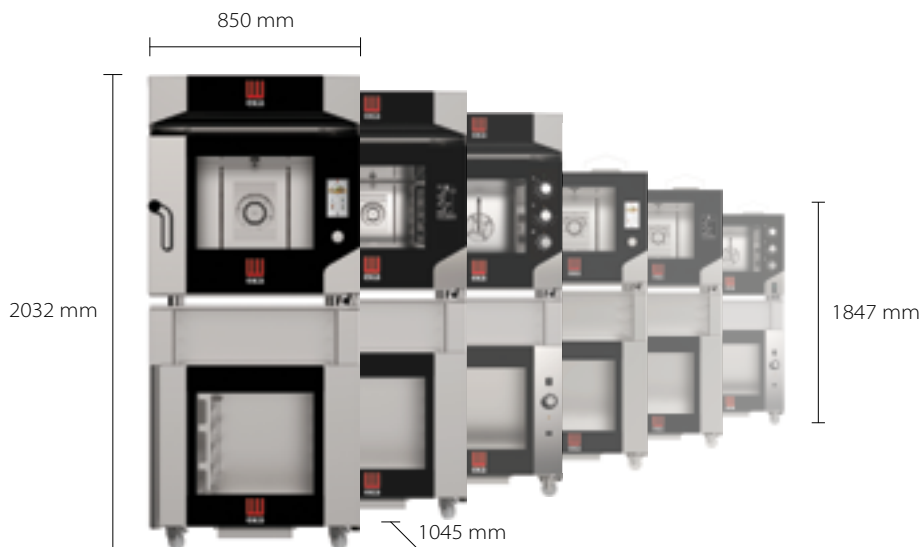

MKF 464 - 4 teglie/trays

MKLM 1064* + MKSST 464
+ MKF 464 TS** + MKKC 4***

*Disponibile versione MKL 1064 S per forni S, G S
**Disponibile versione BM, S e G TS, G BM, G S (senza cappa)
***Disponibile versione MKKC 4 S per forno S

*MKL 1064 S version available for S, G S ovens
**BM, S version available, G TS, G BM, G S (without hood)
***MKKC 4 S version available for S oven

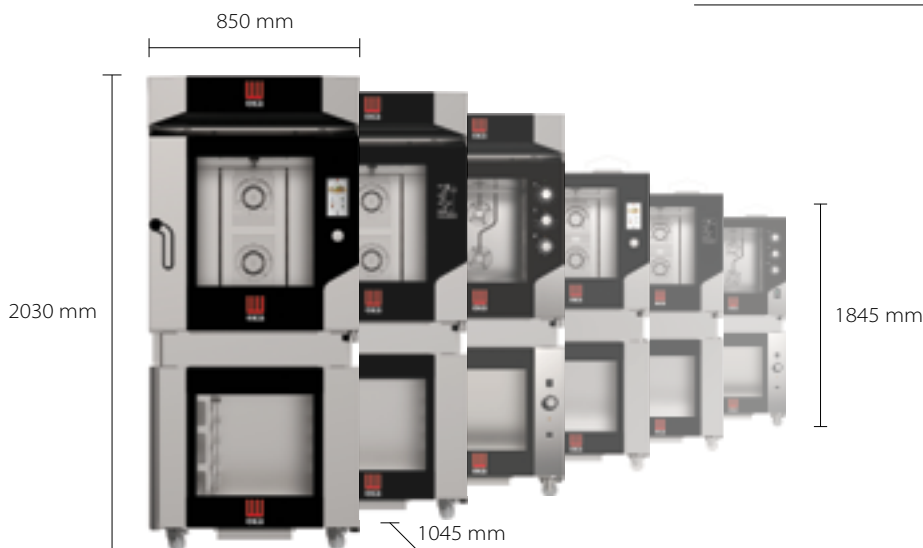

MKF 664 - 6 teglie/trays

MKLM 1064* + MKST 664
+ MKF 664 TS** + MKKC 610***

*Disponibile versione MKL 1064 S per forni S, G S
**Disponibile versione BM, S e G TS, G BM, G S (senza cappa)
***Disponibile versione MKKC 610 S per forno S

*MKL 1064 S version available for S, G S ovens
**BM, S version available, G TS, G BM, G S (without hood)
***MKKC 610 S version available for S oven

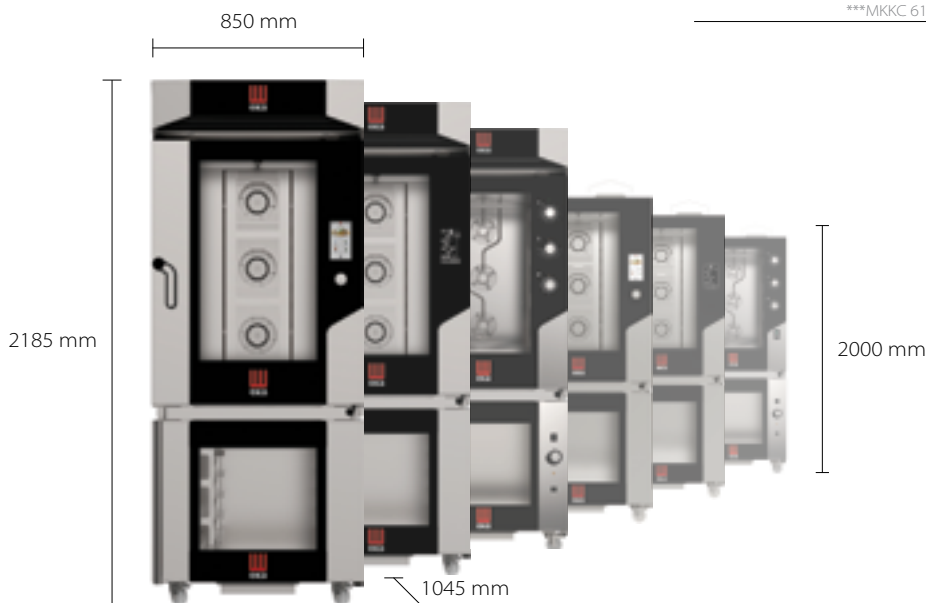

MKF 1064 - 10 teglie/trays

MKLM 1064* + MKS 64
+ MKF 1064 TS** + MKKC 610***

*Disponibile versione MKL 1064 S per forni S, G S
**Disponibile versione BM, S e G TS, G BM, G S (senza cappa)
***Disponibile versione MKKC 610 S per forno S

*MKL 1064 S version available for S, G S ovens
**BM, S version available, G TS, G BM, G S (without hood)
***MKKC 610 S version available for S oven

MKF 464 - 4 teglie/trays

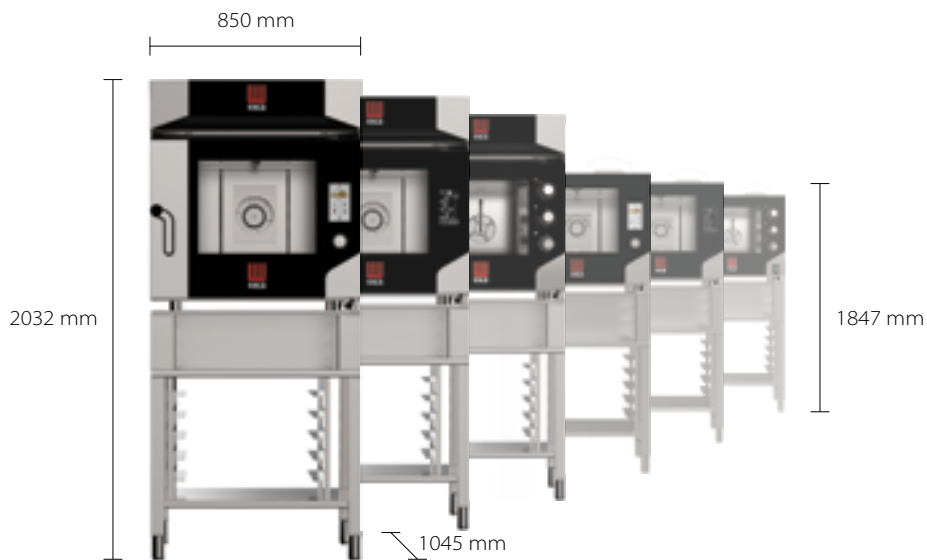

MKTS 64 + MKSST 464
+ MKF 464 TS** + MKKC 4***

**Disponibile versione BM, S e G TS, G BM, G S (senza cappa)
***Disponibile versione MKKC 4 S per forno S

**BM, S version available, G TS, G BM, G S (without hood)
***MKKC 4 S version available for S oven

MKF 664 - 6 teglie/trays

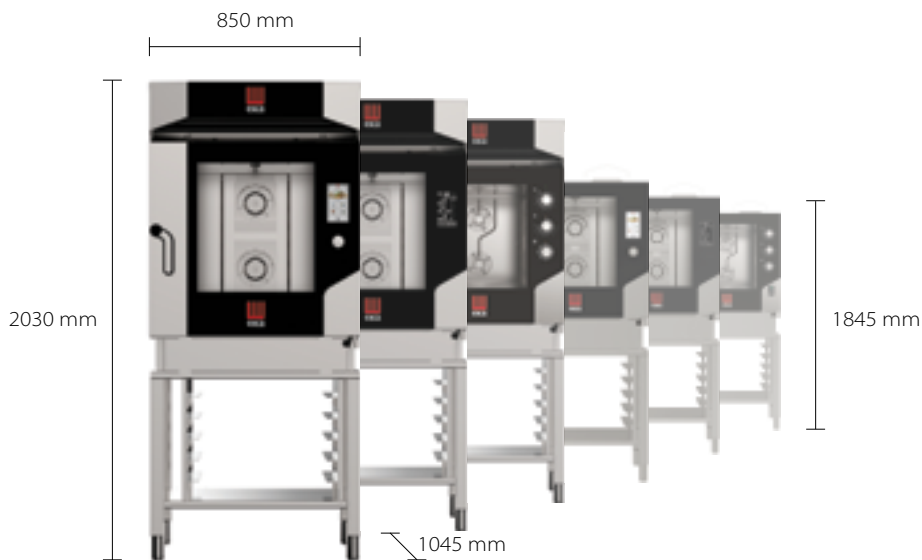

MKTS 64 + MKST 664
+ MKF 664 TS** + MKKC 610***

**Disponibile versione BM, S e G TS, G BM, G S (senza cappa)
***Disponibile versione MKKC 610 S per forno S

**BM, S version available, G TS, G BM, G S (without hood)
***MKKC 610 S version available for S oven

MKF 1064 - 10 teglie



MKTS 64 + MKS 64
+ MKF 1064 TS** + MKKC 610***

**Disponibile versione BM, S e G TS, G BM, G S (senza cappa)
***Disponibile versione MKKC 610 S per forno S

**BM, S version available,
G TS, G BM, G S (without hood)
***MKKC 610 S version available for S oven

MKF 1664 - 16 teglie/trays

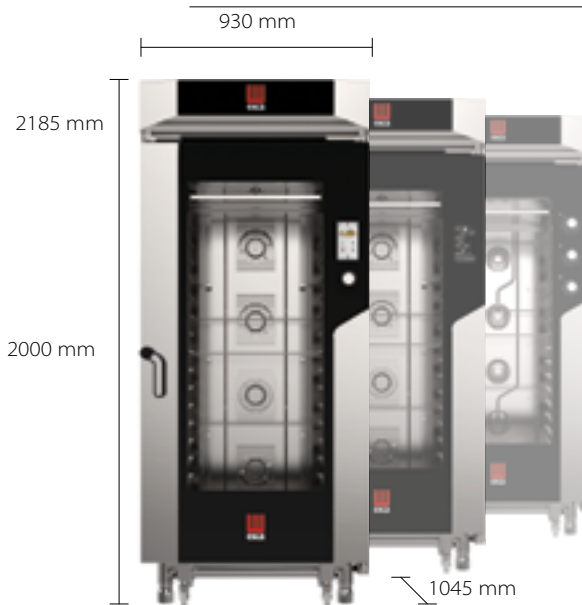

MKF 1664 TS** + MKKC 1620***

**Disponibile versione BM, S
***Disponibile versione MKKC 1620 S per forno S

**BM, S version available
***MKKC 1620 S version available for S oven

Modular design 600 x 400 mm

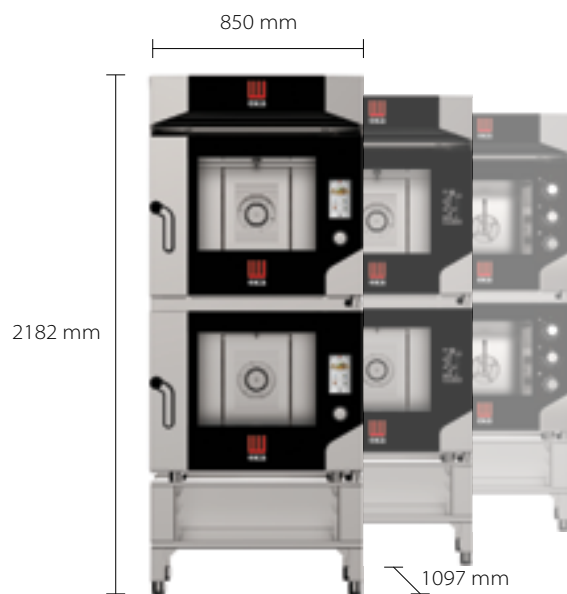

MKF 464 - 4 + 4 teglie/trays

* MKT 64 D + MKSST 464 + MKF 464 TS**
+ MKS 64 + MKF 464 TS** + MKKC 610*** + MKCKIT

**Disponibile versione BM e S
***Disponibile versione MKKC 610 S per forno S

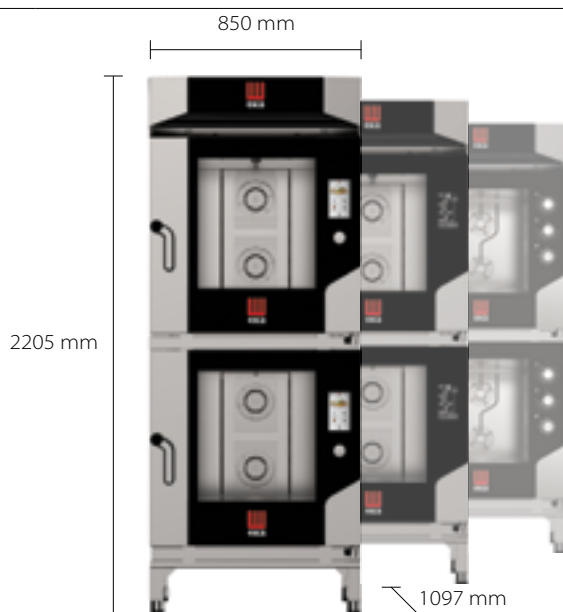

MKF 664 - 6 + 6 teglie/trays

* MKT 64 D + MKS 64 + MKF 664 TS**
+ MKS 64 + MKF 664 TS** + MKKC 610*** + MKCKIT

**Disponibile versione BM e S
***Disponibile versione MKKC 610 S per forno S

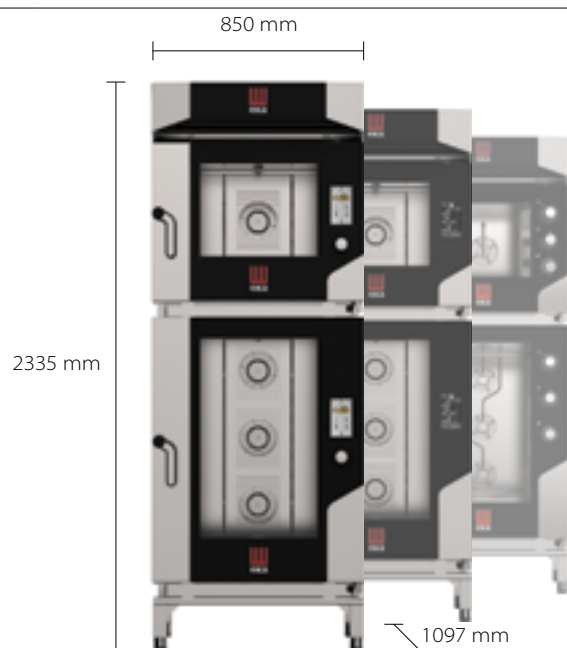

**MKF 1064 - MKF 464
10 + 4 teglie/trays**

* MKT 64 D + MKS 64 + MKF 1064 TS**
+ MKS 64 + MKF 464 TS** + MKKC 610*** + MKCKIT

**Disponibile versione BM e S
***Disponibile versione MKKC 610 S per forno S

* In caso di sovrapposizione tra due forni la profondità totale della colonna aumenta di 62 mm
* In case of overlap between two ovens the total depth of the column increases by 62 mm

**BM, S version available
***MKKC 610 S version available for S oven

MKF D1T - 1 teglia/trays

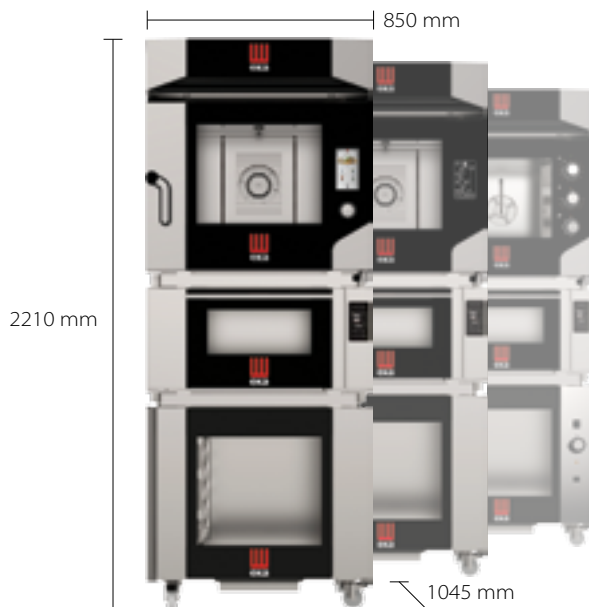

**Modular design
DECK**

MKLM 1064* + MKS 64 + **MKF D1T** +
MKS 64 + MKF 464 TS** + MKKC 610***

*Disponibile versione MKL 1064 S per forno S
**Disponibile versione BM e S
***Disponibile versione MKKC 610 S per forno S

*MKL 1064 S version available for S
**BM, S version available
***MKKC 610 S version available for S oven

MKF D1T - 1 teglia/ trays

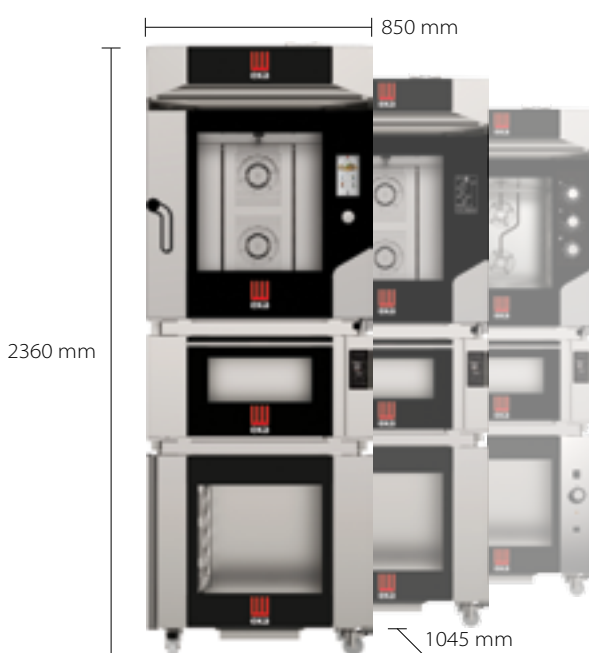

MKLM 1064* + MKS 64 + **MKF D1T** +
MKS 64 + MKF 664 TS** + MKKC 610***

*Disponibile versione MKL 1064 S per forno S
**Disponibile versione BM e S
***Disponibile versione MKKC 610 S per forno S

*MKL 1064 S version available for S
**BM, S version available
***MKKC 610 S version available for S oven

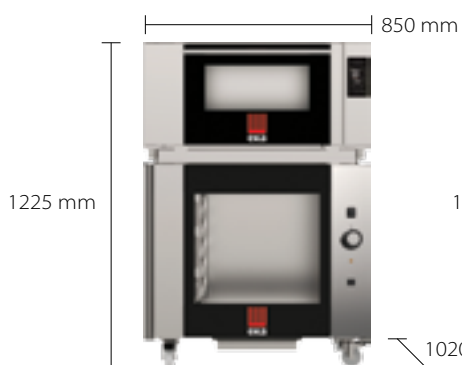

MKL 1064 S + MKS 64 + **MKF D1T**

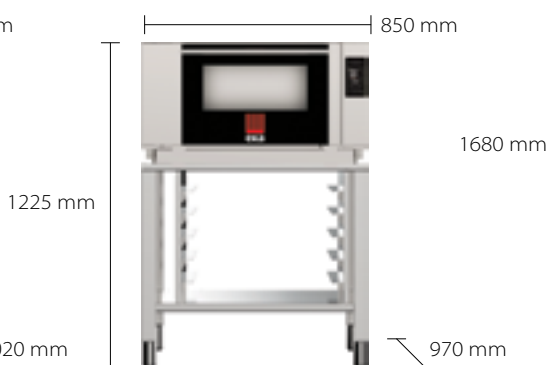

MKTS 64 + MKS 64 + **MKF D1T**

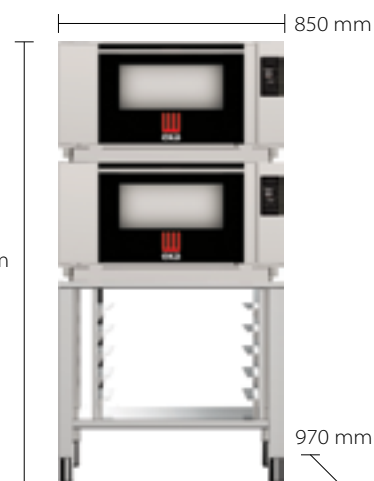

MKTS 64 + MKS 64 + **MKF D1T** +
MKS 64 + **MKF D1T**

MKF D1T - 1 teglia/trays

Modular design DECK

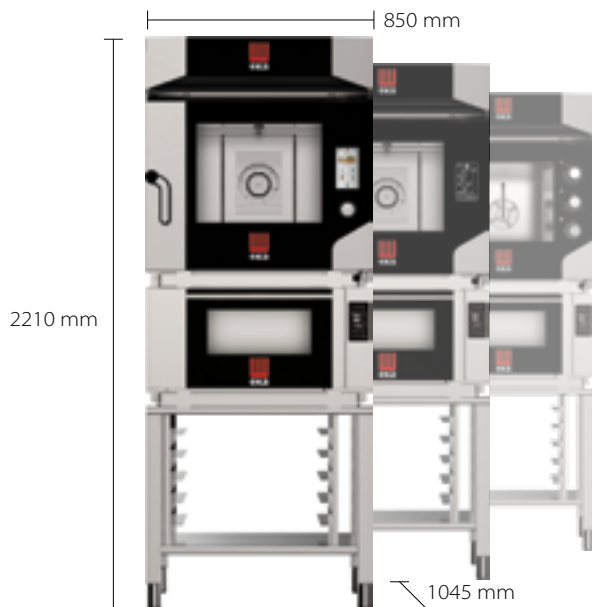

MKF D1T - 1 teglia/trays

MKTS 64 + MKS 64 + **MKF D1T** +
MKS 64 + MKF 464 TS** + MKKC 610***

**Disponibile versione BM e S
***Disponibile versione MKKC 610 S per forno S

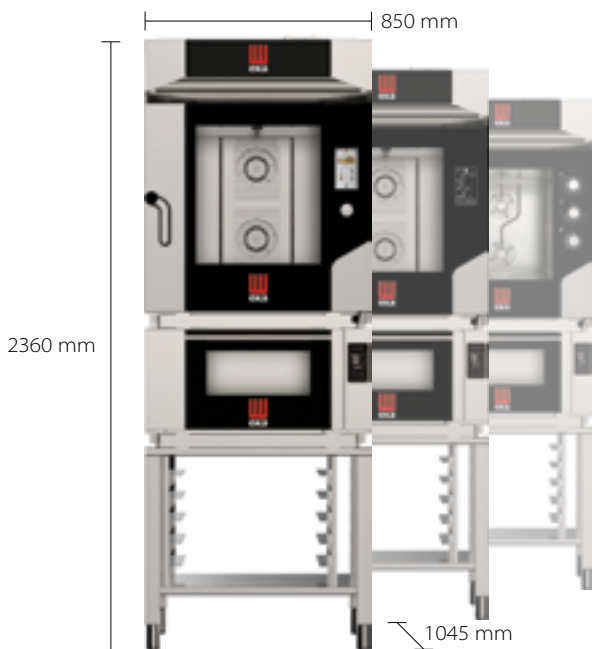

MKF D1T - 1 teglia/trays

MKTS 64 + MKS 64 + **MKF D1T** +
MKS 64 + MKF 664 TS** + MKKC 610***

**Disponibile versione BM e S
***Disponibile versione MKKC 610 S per forno S

**BM, S version available
***MKKC 610 S version available for S oven

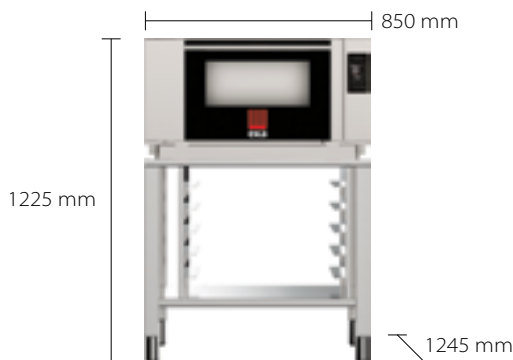

MKF D2T - 2 teglie/trays

MKTSD 2T + MKS 64 + MKF D2T

	MKF 464 S	MKF 464 BM	MKF 464 TS	MKF 4642 TS	MKF 664 SP	MKF 664 S	MKF 664 BM	MKF 664 TS	MKF 1064 S	MKF 1064 BM	MKF 1064 TS	MKF 1664 S	MKF 1664 BM	MKF 1664 TS	MKF 464 G S	MKF 464 G BM	MKF 464 G TS	MKF 664 G S	MKF 664 G BM	MKF 664 G TS	MKF 1064 G S	MKF 1064 G BM	MKF 1064 G TS	MKF 1664 G BM	MKF 1664 G TS	MKF 1T	MKF 2T
MKM 1211																											
MKL 1064 S	•				•	•			•						•						•						•
MKLM 1064	•	•	•	•			•	•		•	•				•	•			•	•		•	•				
MKCC 5 S																											
MKCC 5																											
MKCC 711 S																											
MKCC 711																											
MKCC 1620 S												•															
MKCC 1620												•	•														
MKCC 623 C																											
MKCC 610 C																											
MKCC 4 S	•																										
MKCC 4	•	•	•	•																							
MKCC 610 S	•	•	•	•	•	•	•	•	•	•	•	•	•	•													
MKCC 610	•	•	•	•	•	•	•	•	•	•	•	•	•	•													
MKTS 11																											
MKT 11 D																											
MKTS 21																											
MKTS 623 C																											
MKT 623 DC																											
MKTS 11 C																											
MKT 11 DC																											
MKTPL																											
MKTS 64	•	•	•	•	•	•	•	•	•	•	•	•	•	•	•	•	•	•	•	•	•	•	•	•	•	•	•
MKT 64 D	•	•	•	•	•	•	•	•	•	•	•	•	•	•	•	•	•	•	•	•	•	•	•	•	•	•	•
MKTS D 2T																											•
EKCR 20 TC																											
EKCR 16 TC												•	•	•											•	•	
EKCR 1664	•	•	•	•	•	•	•	•	•	•	•	•	•	•	•	•	•	•	•	•	•	•	•	•	•	•	•
EKCD	•	•	•	•		•	•	•	•	•	•	•	•	•	•	•	•	•	•	•	•	•	•	•	•	•	•
MKSCMO			•	•				•		•				•					•			•			•		
MKSCMU/A			•	•				•		•				•					•			•			•		
MKSCSV			•	•				•		•				•					•			•			•		
MKSSC/A			•	•				•		•				•					•			•			•		
EKSCS		•					•			•			•						•			•			•		
MKAF	•	•	•	•	•	•	•	•	•	•	•	•	•	•	•	•	•	•	•	•	•	•	•	•	•	•	•
MKCG																											
EKFCA																											
RCA																											
MKBZ			•	•				•		•				•				•			•			•			•
MKWT		•					•			•				•				•			•			•			•
MKDET		•	•	•			•	•		•				•				•			•			•			•
MKDETS		•	•	•			•	•		•				•				•			•			•			•
KAF	•	•	•	•		•	•	•	•	•	•	•	•	•	•	•	•	•	•	•	•	•	•	•	•	•	•
KTA	•	•	•	•		•	•	•	•	•	•	•	•	•	•	•	•	•	•	•	•	•	•	•	•	•	•
KCA	•	•	•	•		•	•	•	•	•	•	•	•	•	•	•	•	•	•	•	•	•	•	•	•	•	•
MKKPI	•	•	•	•	•	•	•	•	•	•	•	•	•	•	•	•	•	•	•	•	•	•	•	•	•	•	•
MKCKIT		•	•	•			•	•		•	•			•													
MKCSKIT	•				•	•			•			•															
MKS 11																											
MKS 23 C																											
MKS 623 C																											
MKS 11 C																											
MKS 611 C																											
MKST 711																											
MKSST 511																											
MKSST 623 C																											
MKSST 611 C																											
MKS 64	•	•	•	•	•	•	•	•	•	•	•									•		•				•	•
MKST 664					•	•	•	•										•	•	•							
MKSST 464	•	•	•	•											•	•	•										
KT9P/A	•	•	•	•	•	•	•	•	•	•	•	•	•	•	•	•	•	•	•	•	•	•	•	•	•	•	•
KT9P/B	•	•	•	•	•	•	•	•	•	•	•	•	•	•	•	•	•	•	•	•	•	•	•	•	•	•	•
KTF8P/A	•	•	•	•	•	•	•	•	•	•	•	•	•	•	•	•	•	•	•	•	•	•	•	•	•	•	•
KTF8PT/A	•	•	•	•	•	•	•	•	•	•	•	•	•	•	•	•	•	•	•	•	•	•	•	•	•	•	•
KG9P	•	•	•	•	•	•	•	•	•	•	•	•	•	•	•	•	•	•	•	•	•	•	•	•	•	•	•
KG9PX	•	•	•	•	•	•	•	•	•	•	•	•	•	•	•	•	•	•	•	•	•	•	•	•	•	•	•
KTF9P	•	•	•	•	•	•	•	•	•	•	•	•	•	•	•	•	•	•	•	•	•	•	•	•	•	•	•
KTF9PT	•	•	•	•	•	•	•	•	•	•	•	•	•	•	•	•	•	•	•	•	•	•	•	•	•	•	•
KG5CPX	•	•	•	•	•	•	•	•	•	•	•	•	•	•	•	•	•	•	•	•	•	•	•	•	•	•	•
KPP64	•	•	•	•	•	•	•	•	•	•	•	•	•	•	•	•	•	•	•	•	•	•	•	•	•	•	•
EKT64RG	•	•	•	•	•	•	•	•	•	•	•	•	•	•	•	•	•	•	•	•	•	•	•	•	•	•	•
KG64/A	•	•	•	•	•	•	•	•	•	•	•	•	•	•	•	•	•	•	•	•	•	•	•	•	•	•	•
MKSBX 416	•	•	•	•											•	•	•										
MKSBX 616					•	•	•	•									•	•	•								
MKSBX 1016									•	•	•										•	•	•				



Tecnoeka srl

via Marco Polo, 11 - 35010 Borgoricco, Padova - Italy
Tel. +39.049.5791479 - Tel. +39.049.9300344 - Fax +39.049.5794387

email

info@tecnoeka.com - tecnoekasrl@pec.it

Tecnoeka Iberica S.L.

Cambrils a Reus TV 3141, Km 5,7
43206 Reus (Tarragona)
España
Tel. +34 977 900 198
administracion@tecnoeka.com

Tecnoeka Inc.

3385 Denver Drive
28037 Denver, North Carolina
USA
Tel. +1 704 924-0307
info.usa@tecnoeka.com

Tecnoeka Asia Sdn. Bhd.

No. 32-1, Jalan Puteri 1/2
Bandar Puteri
47100 Puchong
Selangor, Malaysia
Tel. +60 124713100
info.tecnoekaasia@tecnoeka.com

web site

tecnoeka.com

